

S Couplers

Series *KK*

- With sleeve lock (Except for KK2)
- Effective area **3.8 to 82 mm²**



Series *KKH*

- Without sleeve lock
- Effective area is equivalent to that of Series KK.



The pulling strength for the plugs and sockets has been improved.
Twice as strong as the conventional models.

Series *KKA* Stainless steel type

- Body material: Stainless steel 304
- Seal material: Special FKM
- Non-greased specification
- Operating temperature range:
-5 to 150°C



Connection port size
1, 1¹/₄, 1¹/₂ is newly added.
(Series KKA7/8/9)

Series *KK13* Manufactured by RECTUS AG



Variations

Series KK P.2 to 10

Male thread type

Series	Port size					
	M5	R1/8	R1/4	R3/8	R1/2	R3/4
KK2	●	●				
KK3		●	●	●		
KK4		●	●	●	●	
KK6				●	●	●

Female thread type

Series	Port size				
	M5	Rc1/8	Rc1/4	Rc3/8	Rc1/2
KK2	●				
KK3		●	●	●	
KK4			●	●	●
KK6				●	●

Nut fitting type (for fiber reinforced urethane hose)

Series	Applicable hose I.D./O.D. mm					
	5/8	6/9	6.5/10	8/12	8.5/12.5	11/16
KK3	●	●	●			
KK4	●	●	●	●	●	
KK6				●	●	●

One-touch fitting type (Straight/Elbow/Bulkhead)

Series	Applicable tubing O.D. mm						
	ø3.2	ø4	ø6	ø8	ø10	ø12	ø16
KK2	●						
KK3		●	●	●	●		
KK4			●	●	●	●	
KK6						●	●



Series KK3/4/6



Series KK2

Series KKH P.11 to 13

Male thread type

Series	Port size			
	R1/8	R1/4	R3/8	R1/2
KKH3	●	●	●	
KKH4	●	●	●	●

Female thread type

Series	Port size		
	Rc1/8	Rc1/4	Rc3/8
KKH3	●		
KKH4	●	●	●

Nut fitting type (for fiber reinforced urethane hose)

Series	Applicable hose I.D./O.D. mm				
	5/8	6/9	6.5/10	8/12	8.5/12.5
KKH3	●	●	●		
KKH4	●	●	●	●	●



Series KKA Stainless steel type P.14 to 21

Male/Female thread type

Series	Port size							
	R-Rc1/8	R-Rc1/4	R-Rc3/8	R-Rc1/2	R-Rc3/4	R-Rc1	R-Rc1 1/4	R-Rc1 1/2
KKA3	●		●					
KKA4		●	●	●				
KKA6			●	●	●			
KKA7				●	●	●		
KKA8					●		●	
KKA9						●	●	●



Series KK13 Manufactured by RECTUS AG P.22 to 26

Male thread type

Series	Port size			
	R1/8	R1/4	R3/8	R1/2
KK13	●	●	●	●

Female thread type

Series	Port size			
	Rc1/4	Rc3/8	Rc1/2	G1/4
KK13	●	●	●	●

Barb fitting type

Series	Applicable hose I.D.			
	1/4"	1/4"	3/8"	1/2"
KK13	●	●	●	●

Plug nut fitting type (for fiber reinforced urethane hose)

Series	Applicable hose I.D./O.D. mm				
	5/8	6/9	6.5/10	8/12	8.5/12.5
KK13	●	●	●	●	●



S Couplers

Series KK



The pulling strength for the plugs and sockets has been improved.

Twice

as strong as the conventional models

We standardized the product with a sleeve cover. Changing the the lock ring material to a shock absorbent PBT further improved the shock absorbent performance.

Employs a unique connection method

A slim body design and large effective area are achieved with a construction that does not use steel balls and therefore does not restrict the flow path.

● **Lock ring**
Shock absorbent PBT

● **No spring located in the flow path**
Loss of effective area is minimised because there is no valve spring to block the flow path.

● **Check valve end configuration facilitates rectifying effect**
Allows smooth flow of fluids.

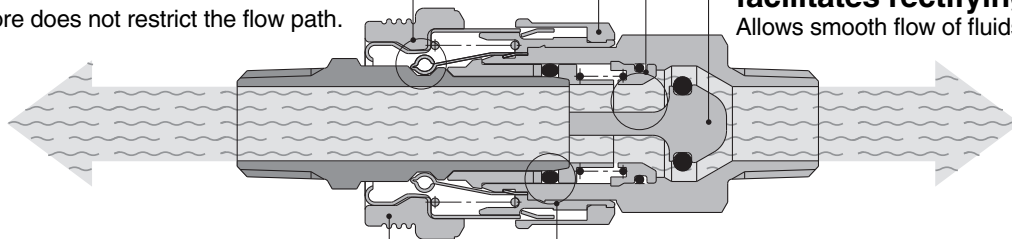

● **Sleeve cover**

(Except for Series KK2)

● **Low leakage seal construction**

Reliable sealing is achieved by surface contact.

● Light weight

Together with a reduction of the body size, pressing parts and resin parts are used to achieve an overall weight reduction.

Series	Plug no.	Socket no.	Effective area mm ² <small>Note 1)</small>	Body O.D. mm	Weight g <small>Note 2)</small>
Series KK2	KK2P-M5M	KK2S-M5M	3.8	ø10.0	6.1
Series KK3	KK3P-01MS	KK3S-01MS	20	ø20.2	20.1
Series KK4	KK4P-02MS	KK4S-02MS	39	ø28.0	44.1
Series KK6	KK6P-04MS	KK6S-04MS	82	ø31.6	90.1

Note 1) Values when plug and socket are connected.

Note 2) Values for socket only.

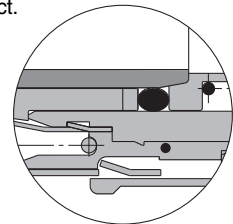

■ One-touch fitting type standardized

Three types from ø4 to ø16 added to series.

■ Flow is possible from the plug side or socket side.

■ Fluids: Air and Water

■ One-touch connection

Simple connection with one hand simplifies work.

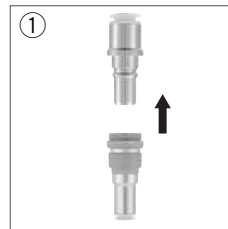

■ Sleeve lock mechanism

Prevents accidents caused by unexpected separation.

Note) Except for M5 type (Series KK2).

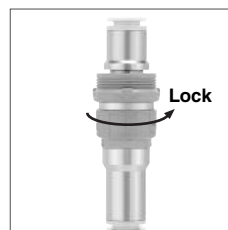

Series KK

Plug (P)

Male thread type



Body size	Port size	Part no.
M5	M5	KK2P-M5M
	R 1/8	-01MS
1/8	R 1/8	KK3P-01MS
	R 1/4	-02MS
	R 3/8	-03MS
1/4	R 1/8	KK4P-01MS
	R 1/4	-02MS
	R 3/8	-03MS
	R 1/2	-04MS
1/2	R 3/8	KK6P-03MS
	R 1/2	-04MS
	R 3/4	-06MS

Female thread type



Body size	Port size	Part no.
M5	M5	KK2P-M5F
1/8	Rc 1/8	KK3P-01F
	Rc 1/4	-02F
	Rc 3/8	-03F
1/4	Rc 1/4	KK4P-02F
	Rc 3/8	-03F
1/2	Rc 3/8	KK6P-03F
	Rc 1/2	-04F

Nut fitting type (for fiber reinforced urethane hose)



Body size	Applicable hose I.D./O.D. mm	Part no.
1/8	5/8	KK3P-50N
	6/9	-60N
	6.5/10	-65N
1/4	5/8	KK4P-50N
	6/9	-60N
	6.5/10	-65N
	8/12	-80N
1/2	8.5/12.5	-85N
	8/12	KK6P-80N
	8.5/12.5	-85N
	11/16	-110N

Straight type with One-touch fitting



Body size	Applicable tubing O.D. mm	Part no.
M5	3.2	KK2P-23H
	4	-04H
	6	-06H
1/8	4	KK3P-04H
	6	-06H
	8	-08H
	10	-10H
1/4	6	KK4P-06H
	8	-08H
	10	-10H
1/2	12	KK6P-12H
	12	-12H
	16	-16H

Elbow type with One-touch fitting



Body size	Applicable tubing O.D. mm	Part no.
M5	3.2	KK2P-23L
	4	-04L
	6	-06L
1/8	4	KK3P-04L
	6	-06L
	8	-08L
	10	-10L
1/4	6	KK4P-06L
	8	-08L
	10	-10L
1/2	12	KK6P-12L
	12	-12L
	16	-16L

Bulkhead type with One-touch fitting



Body size	Applicable tubing O.D. mm	Part no.
M5	3.2	KK2P-23E
	4	-04E
	6	-06E
1/8	4	KK3P-04E
	6	-06E
	8	-08E
	10	-10E
1/4	6	KK4P-06E
	8	-08E
	10	-10E
1/2	12	KK6P-12E
	12	-12E
	16	-16E

Socket (S)

Male thread type



Body size	Port size	Part no.
M5	M5	KK2S-M5M
	R 1/8	-01MS
1/8	R 1/8	KK3S-01MS
	R 1/4	-02MS
	R 3/8	-03MS
1/4	R 1/8	KK4S-01MS
	R 1/4	-02MS
	R 3/8	-03MS
	R 1/2	-04MS
1/2	R 3/8	KK6S-03MS
	R 1/2	-04MS
	R 3/4	-06MS

Female thread type



Body size	Port size	Part no.
M5	M5	KK2S-M5F
1/8	Rc 1/8	KK3S-01F
	Rc 1/4	-02F
	Rc 3/8	-03F
1/4	Rc 1/4	KK4S-02F
	Rc 3/8	-03F
1/2	Rc 3/8	KK6S-03F
	Rc 1/2	-04F

Nut fitting type (for fiber reinforced urethane hose)



Body size	Applicable hose I.D./O.D. mm	Part no.
1/8	5/8	KK3S-50N
	6/9	-60N
	6.5/10	-65N
1/4	5/8	KK4S-50N
	6/9	-60N
	6.5/10	-65N
	8/12	-80N
1/2	8.5/12.5	-85N
	8/12	KK6S-80N
	8.5/12.5	-85N
	11/16	-110N

Straight type with One-touch fitting



Body size	Applicable tubing O.D. mm	Part no.
M5	3.2	KK2S-23H
	4	-04H
	6	-06H
1/8	4	KK3S-04H
	6	-06H
	8	-08H
	10	-10H
1/4	6	KK4S-06H
	8	-08H
	10	-10H
1/2	12	KK6S-12H
	12	-12H
	16	-16H

Elbow type with One-touch fitting



Body size	Applicable tubing O.D. mm	Part no.
M5	3.2	KK2S-23L
	4	-04L
	6	-06L
1/8	4	KK3S-04L
	6	-06L
	8	-08L
	10	-10L
1/4	6	KK4S-06L
	8	-08L
	10	-10L
1/2	12	KK6S-12L
	12	-12L
	16	-16L

Bulkhead type with One-touch fitting



Body size	Applicable tubing O.D. mm	Part no.
M5	3.2	KK2S-23E
	4	-04E
	6	-06E
1/8	4	KK3S-04E
	6	-06E
	8	-08E
	10	-10E
1/4	6	KK4S-06E
	8	-08E
	10	-10E
1/2	12	KK6S-12E
	12	-12E
	16	-16E

S Couplers

Series *KK*



Specifications

Fluid	Air, Water (standard industrial water)
Operating pressure range <small>Note)</small>	KK2: -100 kPa to 1.0 MPa KK3: -90 kPa to 1.0 MPa KK4/6: 0 to 1.0 MPa
Proof pressure	1.5 MPa
Ambient and fluid temperature	Air: -5 to 60°C Water: 5 to 40°C (with no freezing)
Plating, Sealant	Electroless nickel plated (copper-free application), With male thread sealant

Note) Do not use the S couplers with a leak tester or for vacuum retention because they are not guaranteed for zero leakage.

Performance

Plug and socket connection	One-touch connection and release
Check valve	Socket: Built-in check valve (standard)
Sleeve lock mechanism <small>Note)</small>	Manual locking type (standard)

Note) Series KK2 is not provided with lock mechanism.

Effective Area

Body size	Plug	Socket	Effective area mm ²
M5	KK2P-M5M	KK2S-M5M	3.8
1/8	KK3P-01MS	KK3S-01MS	20
1/4	KK4P-02MS	KK4S-02MS	39
1/2	KK6P-04MS	KK6S-04MS	82

JIS Symbol

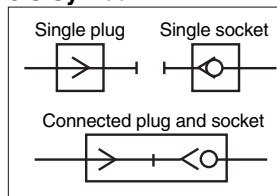

How to Order

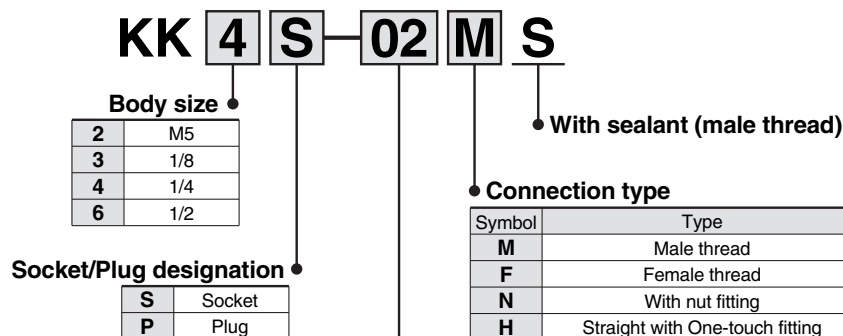

• Piping port size variation

Male/Female thread type	
Symbol	Thread size
M5	M5
01	R, Rc 1/8
02	R, Rc 1/4
03	R, Rc 3/8
04	R, Rc 1/2
06	R, Rc 3/4

One-touch fitting type	
Symbol	Applicable tubing O.D. mm
23	ø3.2
04	ø4
06	ø6
08	ø8
10	ø10
12	ø12
16	ø16

Nut fitting type	
Symbol	Applicable hose I.D./O.D. mm
50	5/8
60	6/9
65	6.5/10
80	8/12
85	8.5/12.5
110	11/16

Note) Please refer to the previous page to confirm the right combination.

Series KK

Flow Characteristics

Air (0 to 1 MPa)

KK2

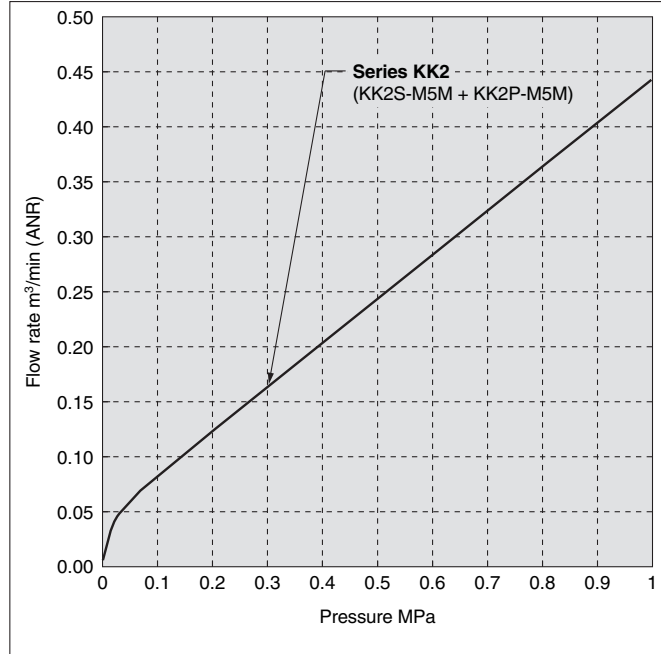

Water (0 to 0.4 MPa)

KK2

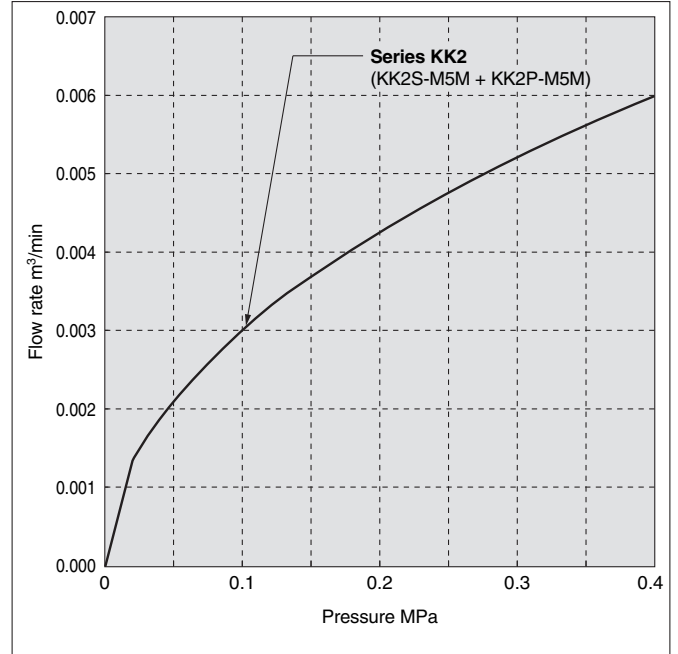

KK3/4/6

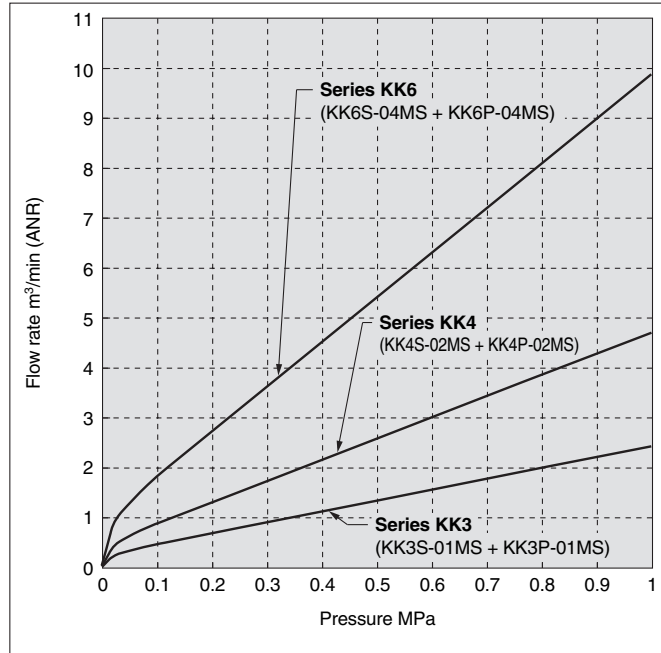

KK3/4/6

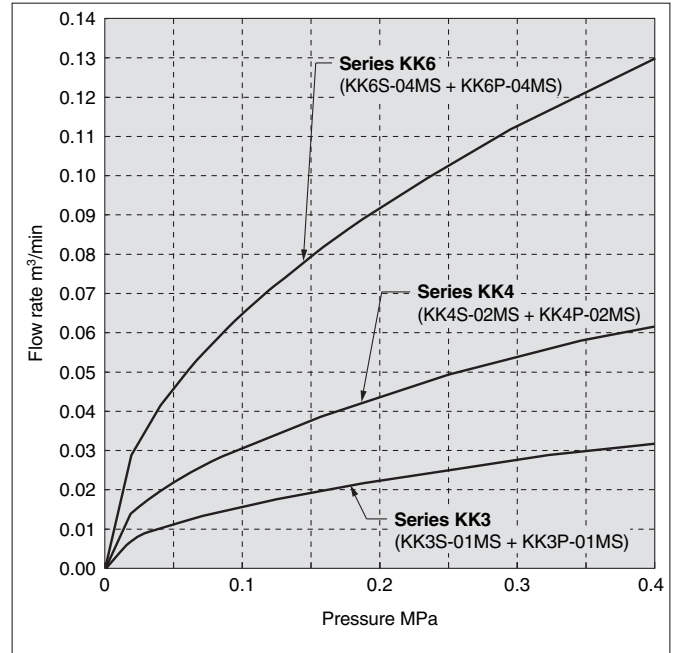

Construction

KK2

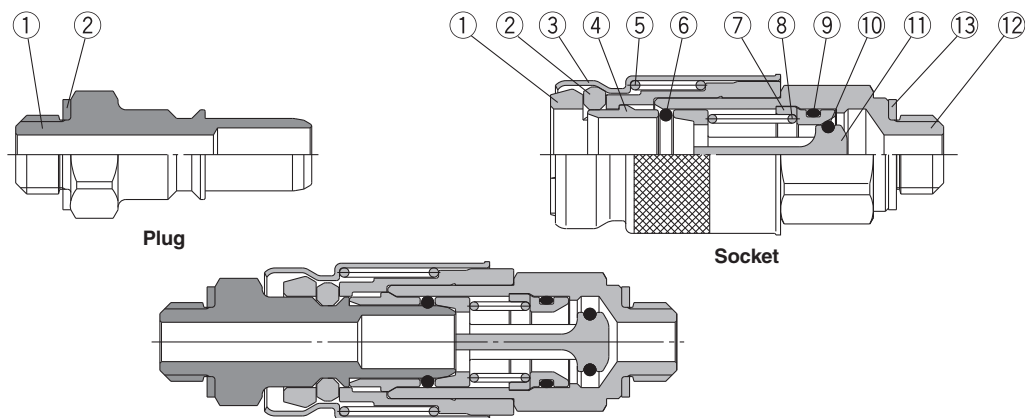

Plug

No.	Description	Material	Note
1	Stem	Brass	Electroless nickel plated
2	Gasket	Stainless steel, NBR	

KK2 Series Spare Parts

Description	Part no.	No.
Gasket	M-5G2	Plug ②
		Socket ⑬

Socket

No.	Description	Material	Note
1	Spacer	PBT	
2	Chuck	PBT	
3	Sleeve	Brass	Electroless nickel plated
4	Collar	Brass	Electroless nickel plated
5	Sleeve spring	Stainless steel	
6	Plug O-ring	NBR	
7	Valve seat	PBT	
8	Valve spring	Stainless steel	
9	Valve seat O-ring	NBR	
10	Valve O-ring	FKM	
11	Valve	PBT	
12	Socket body	Brass	Electro nickel plated
13	Gasket	Stainless steel, NBR	

KK3/4/6

<With One-touch fitting >

<With One-touch fitting >

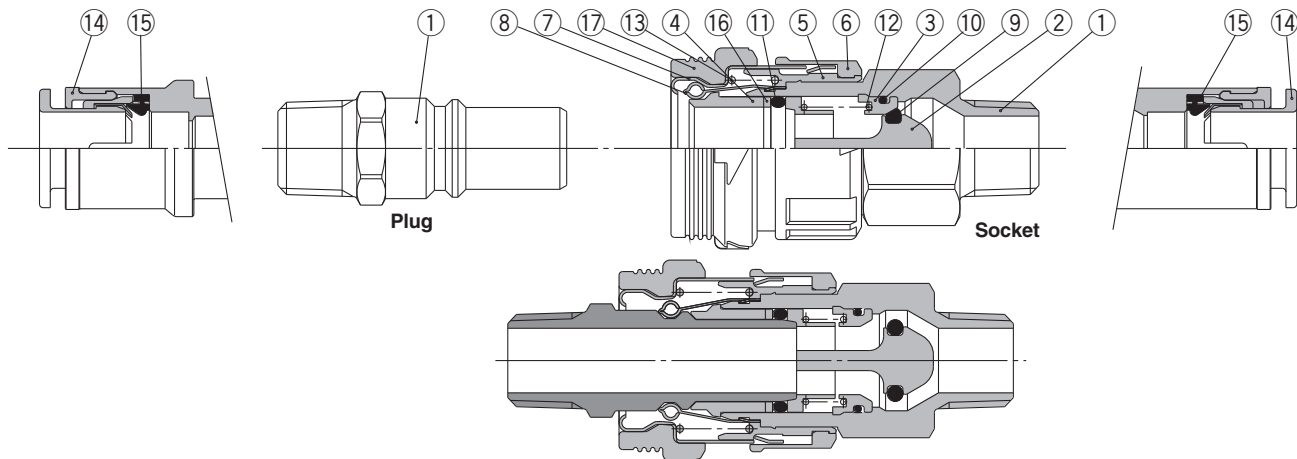

Plug

No.	Description	Material	Note
1	Stem	Brass	Electroless nickel plated
14	Cassette	—	
15	Seal	NBR	

KK/KKH Series Spare Parts

Description	Part no.	No.
Sleeve cover	KK3S-P01	Socket ⑰
	KK4S-P01	
	KK6S-P01	

Socket

No.	Description	Material	Note
1	Body	Brass	Electroless nickel plated
2	Valve	PBT	
3	Valve seat	PBT	
4	Collar	PBT	
5	Spacer	PBT	
6	Lock ring	Shock absorbent PBT	
7	Sleeve	Cold rolled carbon steel sheet	Electroless nickel plated
8	Chuck	Stainless steel	
9	Valve O-ring	FKM	
10	Valve seat O-ring	NBR	
11	Plug O-ring	NBR	
12	Valve spring	Stainless steel	
13	Sleeve spring	Stainless steel	
14	Cassette	—	
15	Seal	NBR	
16	Collar 2	Stainless steel	
17	Sleeve cover	Weather resistant NBR	

Series KK

Dimensions/Plug (P)

Male thread type

KK2



KK3/4/6



Body size	Model	T Connection port size	H Width across flats	L1	L2	A*	Min. bore size	Effective area mm ²	Weight g
M5	KK2P-M5M	M5 x 0.8	7	18.8	12.3	15.8	2.5	4.4	2.6
	-01MS	R 1/8	10	22.3		19.2	3.4	8.1	3.0
	KK3P-01MS	R 1/8	10	29.5		26.4	6.0	22.6	8.4
1/8	-02MS	R 1/4	14	32.9	27.4	14.2			
	-03MS	R 3/8	17	34.3	28.9	28.1			
	1/4	KK4P-01MS	R 1/8	14	36.1	25.2	33.0	9.0	50.9
-02MS		R 1/4	14	39.7	34.2		20.2		
-03MS		R 3/8	17	41.1	35.7		32.5		
-04MS		R 1/2	22	45.3	38.2		57.4		
1/2	KK6P-03MS	R 3/8	19	46.9	31.0	41.5	11.0	76.0	44.7
	-04MS	R 1/2	22	51.1		44.0	13.0	106.2	53.7
	-06MS	R 3/4	27	55		45.5			94.4

* Reference dimension for R threads after installation.

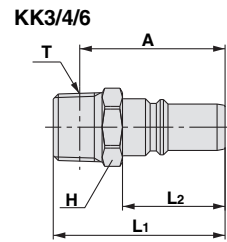
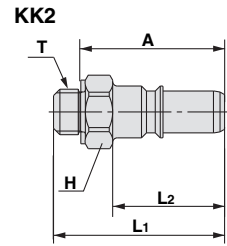

Female thread type



Body size	Model	T Connection port size	H Width across flats	L1	L2	Min. bore size	Effective area mm ²	Weight g
M5	KK2P-M5F	M5 x 0.8	8	17.6	12.3	3.4	8.1	2.6
1/8	KK3P-01F	Rc 1/8	14	28.3	18.4	6.0	22.6	10.4
	-02F	Rc 1/4	17	33.5				20.8
	-03F	Rc 3/8	19	35.3				23.2
1/4	KK4P-02F	Rc 1/4	17	37.2	25.2	9.0	50.9	23.9
	-03F	Rc 3/8	19	39.8				24.6
1/2	KK6P-03F	Rc 3/8	19	43.3	31.0	13.0	106.2	28.6
	-04F	Rc 1/2	24	50.2				43.9

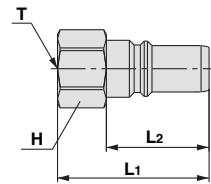

Nut fitting type (for fiber reinforced urethane hose)



Body size	Model	Applicable hose I.D./O.D. mm	H1 Width across flats	H2 Width across flats	L1	L2	M	Min. bore size	Effective area mm ²	Weight g				
1/8	KK3P-50N	5/8	14	14	36.1	18.4	13.7	4.5	12.7	21.4				
	-60N	6/9	17	17	39.9		16.5	5.4	18.3	38.8				
	-65N	6.5/10		16.5	5.9		21.9	35.9						
1/4	KK4P-50N	5/8	17	14	43.9	25.2	13.7	4.5	12.7	34.7				
	-60N	6/9									16.5	5.4	18.3	48.4
	-65N	6.5/10												
	-80N	8/12									17.4	7.4	34.4	53.2
	-85N	8.5/12.5												
-85N	8.5/12.5	7.4	34.4	60.5										
1/2	KK6P-80N	8/12	19	19	53.4	31.0	17.4	7.8	38.2	62.8				
	-85N	8.5/12.5									7.8	38.2	62.8	
	-110N	11/16	24	24	57.2		20.1	10.2	65.4	96.5				

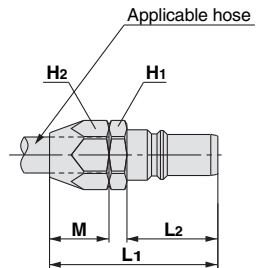

Straight type with One-touch fitting

(mm)

Body size	Model	Applicable tubing O.D. mm	øD1	øD2	L1	L2	M	Min. bore size	Effective area mm ²		Weight g	
									Urethane tubing	Nylon tubing		
M5	KK2P-23H	ø3.2	10.0	7.0	23.7	12.3	12.7	2.5	3.7	4.4	3.3	
	-04H	ø4		8.0	26.7				8.1	8.1	3.4	
	-06H	ø6		10.0	26.7				8.1	8.1	4.0	
1/8	KK3P-04H	ø4	12.0	10.0	35.4	18.4	16.0	3.2	3.9	5.6	7.9	
	-06H	ø6	14.0	12.0					4.7	10.1	12.8	9.1
	-08H	ø8	16.0	14.0					6.0	15.7	22.6	13.2
	-10H	ø10	19.0	17.0					21.0	22.6	22.6	17.6
1/4	KK4P-06H	ø6	14.0	12.0	46.2	25.2	17.0	4.7	10.1	12.8	22.3	
	-08H	ø8	16.0	14.0					6.2	19.8	22.6	23.0
	-10H	ø10	19.0	17.0					7.7	27.6	35.3	27.1
	-12H	ø12	21.0	19.0					9.0	40.2	50.9	30.0
1/2	KK6P-12H	ø12	21.0	19.0	56.1	31.0	22.0	9.2	41.2	50.9	44.4	
	-16H	ø16	26.0	25.7					25.0	13.0	—	106.2

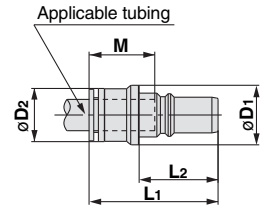

Elbow type with One-touch fitting

(mm)

Body size	Model	Applicable tubing O.D. mm	øD1	øD2	L1	L2	L3	M	Min. bore size	Effective area mm ²		Weight g						
										Urethane tubing	Nylon tubing							
M5	KK2P-23L	ø3.2	10.0	9.3	24.0	12.3	16.5	12.7	2.5	3.6	4.3	5.8						
	-04L	ø4								7.8	7.8	6.4						
	-06L	ø6								10.1	11.4	8.0						
1/8	KK3P-04L	ø4	12.0	15.2	34.0	18.4	18.0	16.0	3.0	3.7	5.3	7.2						
	-06L	ø6								10.1	11.4	8.0						
	-08L	ø8								12.0	15.2	34.0	6.0	15.0	16.8	9.7		
	-10L	ø10								17.0	18.5	36.0	26.5	21.0	18.0	18.5	23.0	
1/4	KK4P-06L	ø6	14.0	15.2	41.4	25.2	20.0	17.0	4.5	10.1	11.4	19.6						
	-08L	ø8								17.0	18.5	6.0	17.5	19.8	21.3			
	-10L	ø10								17.0	18.5	42.8	26.5	21.0	7.5	24.7	27.5	25.7
	-12L	ø10								17.0	18.5	42.8	26.5	21.0	7.5	24.7	27.5	25.7
1/2	KK6P-12L	ø12	19.0	20.9	49.9	31.0	28.5	22.0	9.0	29.0	29.6	28.0						
	-16L	ø16	21.0	26.5	53.5	34.0	25.0	13.0	—	58.7	48.7							

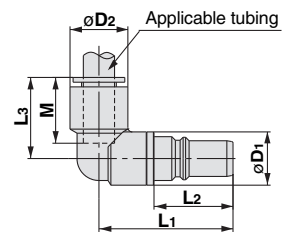

Bulkhead type with One-touch fitting

(mm)

Body size	Model	Applicable tubing O.D. mm	T Threads	H1 Width across flats	H2 Width across flats	L1	L2	L3	M	Min. bore size	Effective area mm ²		Weight g		
											Urethane tubing	Nylon tubing			
M5	KK2P-23E	ø3.2	M8 x 0.75	10	10	28.3	12.3	12.5	12.7	2.5	3.7	4.4	6.0		
	-04E	ø4	M9 x 0.75		11						8.1	8.1	6.6		
	-06E	ø6	M11 x 0.75		14						14	12.7	13.5	9.7	
1/8	KK3P-04E	ø4	M12 x 1	17	17	39.3	18.4	16.9	16.0	3.2	3.9	5.6	16.6		
	-06E	ø6	M14 x 1		17						40.2	4.7	10.1	12.8	22.3
	-08E	ø8	M16 x 1		19						43.4	6.0	15.7	22.6	30.2
	-10E	ø10	M20 x 1		22						46.4	22.0	21.0	22.6	54.7
1/4	KK4P-06E	ø6	M14 x 1	17	17	47.0	25.2	16.8	17.0	4.7	10.1	12.8	30.6		
	-08E	ø8	M16 x 1		19						50.2	6.2	19.8	22.6	38.2
	-10E	ø10	M20 x 1		22						53.2	7.7	27.6	35.3	61.4
	-12E	ø12	M22 x 1		24						54.2	9.0	40.2	50.9	75.2
1/2	KK6P-12E	ø12	M22 x 1	24	27	60.1	31.0	23.0	22.0	9.2	41.2	50.9	86.1		
	-16E	ø16	M28 x 1.5		30						32	62.6	24.5	25.0	13.0

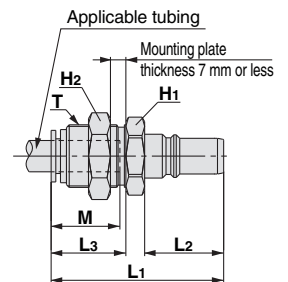



Series KK

Dimensions/Socket (S)

Male thread type

(mm)

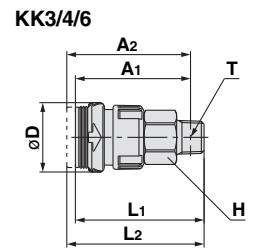
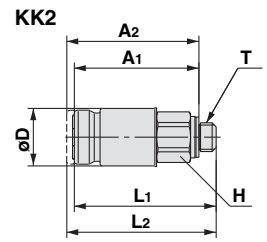

Body size	Model	T Connection port size	H Width across flats	øD	L1	L2 When connected	A1*	A2* When connected	Min. bore size	Effective area mm ²	Weight g	
KK2 	M5	KK2S-M5M	M5	8	10.0	24,7	26,2	21.7	23.7	2.5	3.8	6.1
		-01MS	R 1/8	10		24,4	25,9		22.8	4.7	5.8	9.1
KK3/4/6 	1/8	KK3S-01MS	R 1/8	14	20.2	36,6	39,1	33.5	36.0	6.0	20.4	20.1
		-02MS	R 1/4			37,0	39,5		31.5	34.0	9.0	21.1
		-03MS	R 3/8	17		37,6	40,1	32.2	34.5	9.0	21.1	29.0
1/4	KK4S-01MS	R 1/8	19	28.0	49,5	53,2	46.4	50.1	6.0	22.9	47.5	
	-02MS	R 1/4			50,5	54,2		45.0	48.7	9.0	38.9	44.1
	-03MS	R 3/8	48,9		52,6	43.5	47.2	11.0	40.4	50.9		
	-04MS	R 1/2	22		48,8	52,5	41.7	45.4	13.0	42.7	61.2	
1/2	KK6S-03MS	R 3/8	24	31.6	59,1	64,4	53.7	59.0	11.0	71.7	87.9	
	-04MS	R 1/2			59,3	64,6		52.2	57.5	13.0	82.3	90.1
	-06MS	R 3/4	27		60,2	65,5	50.7	56.0	15.0	83.8	113.3	

* Reference dimension for R threads after installation.



Female thread type

(mm)

Body size	Model	T Connection port size	H Width across flats	øD	L1	L2 When connected	Min. bore size	Effective area mm ²	Weight g	
KK2 	M5	KK2S-M5F	M5	8	10.0	25.3	26.8	4.2	5.4	6.4
		KK3S-01F	Rc 1/8	14		20.2	36.0	38.5	8.2	20.6
KK3/4/6 	1/8	-02F	Rc 1/4	17	40.1		42.6	10.9		21.1
		-03F	Rc 3/8	19	41.9	44.4	38.8			
		1/4	KK4S-02F	Rc 1/4	19	28.0			50.4	54.1
-03F	Rc 3/8	51.1	54.8	14.4			42.7	46.2		
1/2	KK6S-03F	Rc 3/8	24	31.6	58.6	63.9	18.0	83.1	93.6	
	-04F	Rc 1/2			61.0	66.3		83.8	87.4	

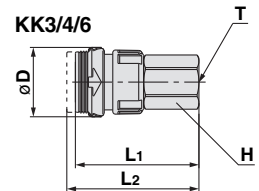
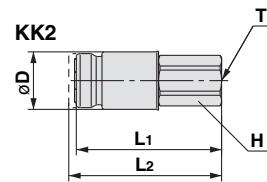

Nut fitting type (for fiber reinforced urethane hose)

(mm)

Body size	Model	Applicable hose I.D./O.D. mm	H1 Width across flats	H2 Width across flats	øD	L1	L2 When connected	M	Min. bore size	Effective area mm ²	Weight g		
1/8	KK3S-50N	5/8	14	14	20.2	42.6	45.1	13.7	4.5	12.2	32.1		
	-60N	6/9	17	17		44.4	46.9	16.5	5.4	18.3	48.7		
	-65N	6.5/10				5.9	19.2	46.4					
1/4	KK4S-50N	5/8	19	14	28.0	54.1	57.8	13.7	4.5	12.2	55.8		
	-60N	6/9				17	17	56.8	60.5	16.5	5.4	20.4	69.3
	-65N	6.5/10						5.9	24.1	66.8			
	-80N	8/12				19	19	55.4	59.1	17.4	7.4	35.1	68.5
	-85N	8.5/12.5						7.8	36.6		71.1		
1/2	KK6S-80N	8/12	24	24	31.6	66.0	71.3	20.1	7.4	36.6	107.5		
	-85N	8.5/12.5				7.8	41.2		110.2				
-110N	11/16	64.4	69.7	20.1	10.2	68.4	119.8						

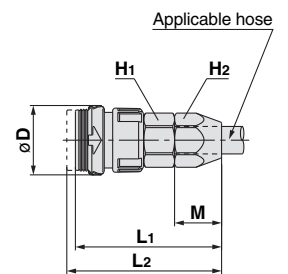

Straight type with One-touch fitting

(mm)

Body size	Model	Applicable tubing O.D. mm	øD1	øD2	L1	L2 When connected	M	Min. bore size	Effective area mm ²		Weight g	
									Urethane tubing	Nylon tubing		
M5	KK2S-23H	ø3.2	10.0	7.0	33.8	35.3	12.7	2.5	3.8	4.6	6.4	
	-04H	ø4		8.0	33.6	35.1		3.4	4.0	4.8	6.5	
	-06H	ø6		10.0	33.9	35.4		4.7	5.8	5.8	7.9	
1/8	KK3S-04H	ø4	20.2	10.0	46.6	49.1	16.0	3.2	3.8	5.8	22.5	
	-06H	ø6		12.0	47.1	49.6		4.7	10.4	13.4	24.4	
	-08H	ø8		14.0	48.9	51.4		18.5	6.2	16.8	18.9	27.3
	-10H	ø10		17.0	49.9	52.4		21.0	7.7	19.1	19.1	37.1
1/4	KK4S-06H	ø6	28.0	12.0	58.2	61.9	17.0	4.7	10.4	13.4	51.4	
	-08H	ø8		14.0	60.1	63.8		18.5	6.2	18.3	21.8	51.3
	-10H	ø10		17.0	61.5	65.2		21.0	7.7	27.0	29.4	54.8
	-12H	ø12		19.0	62.5	66.2		22.0	9.2	30.5	32.0	59.4
1/2	KK6S-12H	ø12	31.6	70.1	75.4				42.7	48.8	84.1	
	-16H	ø16		25.7	72.3				77.6	25.0	13.2	53.4

KK2



KK3/4/6

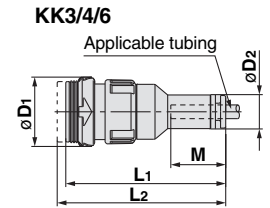
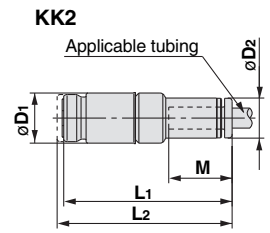

Elbow type with One-touch fitting

(mm)

Body size	Model	Applicable tubing O.D. mm	øD1	øD2	L1	L2 When connected	L3	M	Min. bore size	Effective area mm ²		Weight g
										Urethane tubing	Nylon tubing	
M5	KK2S-23L	ø3.2	10.0	9.3	26.0	27.5	16.5	12.7	2.5	3.7	4.4	6.7
	-04L	ø4		11.6	27.2	28.3	16.6	13.5	4.5	5.6	5.6	7.2
	-06L	ø6		10.4	41.7	44.2	18.0	16.0	3.0	3.7	5.3	23.2
1/8	KK3S-04L	ø4	20.2	12.8	42.9	45.4	20.0	17.0	4.5	10.1	11.4	24.0
	-06L	ø6		15.2	43.1	45.6	23.0	18.5	6.0	15.0	16.8	25.0
	-08L	ø8		18.5	42.9	45.4	26.5	21.0	7.5	18.0	18.5	34.4
	-10L	ø10		12.8	54.3	58.0	20.0	17.0	4.5	10.1	11.4	53.5
1/4	KK4S-06L	ø6	28.0	15.2	55.5	59.2	23.0	18.5	6.0	17.5	19.8	53.1
	-08L	ø8		18.5	54.2	57.9	26.5	21.0	7.5	24.7	27.5	54.7
	-10L	ø10		20.9	55.4	59.1	28.5	22.0	9.0	29.0	29.6	57.0
	-12L	ø12		66.3	71.6	28.5	22.0	9.0	29.0	29.6	57.0	
1/2	KK6S-12L	ø12	31.6	26.5	66.9	72.2	34.0	25.0	13.0	38.1	39.7	91.4
	-16L	ø16		26.5	66.9	72.2	34.0	25.0		50.3	58.7	93.5

KK2



KK3/4/6

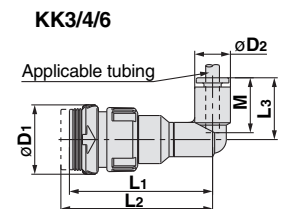
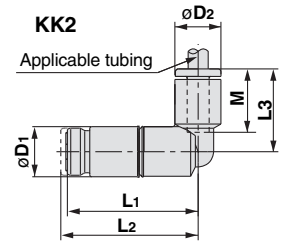

Bulkhead type with One-touch fitting

(mm)

Body size	Model	Applicable tubing O.D. mm	T Threads	H1 Width across flats	H2 Width across flats	øD	L1	L2 When connected	L3	M	Min. bore size	Effective area mm ²		Weight g		
												Urethane tubing	Nylon tubing			
M5	KK2S-23E	ø3.2	M8 x 0.75	10	10	10.0	33.8	35.3	13.0	12.7	2.5	3.8	4.6	9.6		
	-04E	ø4	M9 x 0.75		11		33.5	35.0			3.4	4.0	4.8	9.1		
	-06E	ø6	M11 x 0.75		14		33.9	35.4			4.7	5.8	5.8	12.6		
1/8	KK3S-04E	ø4	M12 x 1	14	14	20.2	46.6	49.1	16.0	16.0	3.2	3.8	5.8	29.0		
	-06E	ø6	M14 x 1		17		47.1	49.6			4.7	10.4	13.4	39.4		
	-08E	ø8	M16 x 1		19		49.0	51.5			20.0	18.5	6.2	16.8	18.9	43.4
	-10E	ø10	M20 x 1		22		49.9	52.4			22.0	21.0	7.7	19.1	19.1	68.3
1/4	KK4S-06E	ø6	M14 x 1	19	17	28.0	58.2	61.9	17.0	17.0	4.7	10.4	13.4	57.2		
	-08E	ø8	M16 x 1		19		60.1	63.8			20.0	18.5	6.2	18.3	21.8	60.6
	-10E	ø10	M20 x 1		22		61.7	65.4			22.0	21.0	7.7	27.0	29.4	86.8
	-12E	ø12	M22 x 1		24		62.7	66.4			23.0	22.0	9.2	30.5	32.0	105.7
1/2	KK6S-12E	ø12	M22 x 1	24	27	31.6	70.1	75.4	24.5	25.0	9.2	42.7	48.8	116.0		
	-16E	ø16	M28 x 1.5		30		72.5	77.8				13.2	53.4	62.5	183.2	

KK2



KK3/4/6

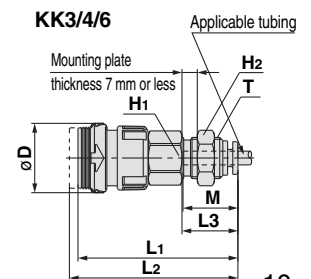
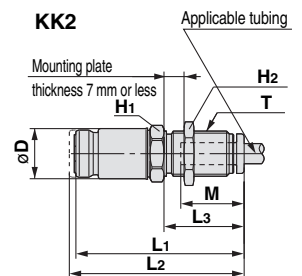

S Couplers

Series KKH



- Able to absorb drop impact (equivalent to impact energy of 0.5 J).
- The pulling strength for the plugs and sockets has been improved. Twice as strong as the conventional models.

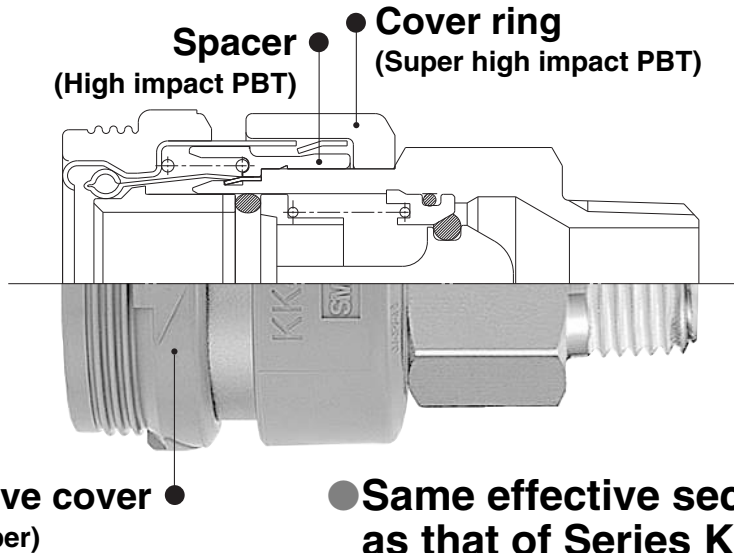

- Same effective sectional area as that of Series KK.

Plug (P)

Male thread type

Image	Body size	Connection port size	Part no.
		R 1/8	KK3P-01MS
	1/8	R 1/4	-02MS
		R 3/8	-03MS
		R 1/8	KK4P-01MS
	1/4	R 1/4	-02MS
		R 3/8	-03MS
		R 1/2	-04MS

Female thread type

Image	Body size	Connection port size	Part no.
		Rc 1/8	KK3P-01F
	1/8	Rc 1/4	-02F
		Rc 3/8	-03F
		Rc 1/4	KK4P-02F
	1/4	Rc 3/8	-03F

Nut fitting type (for fiber reinforced urethane hose)

Image	Body size	Applicable hose I.D./O.D. mm	Part no.
		5/8	KK3P-50N
	1/8	6/9	-60N
		6.5/10	-65N
		5/8	KK4P-50N
	1/4	6/9	-60N
		6.5/10	-65N
		8/12	-80N
		8.5/12.5	-85N

Socket (S)

Male thread type

Image	Body size	Connection port size	Part no.
		R 1/8	KKH3S-01MS
	1/8	R 1/4	-02MS
		R 3/8	-03MS
		R 1/8	KKH4S-01MS
	1/4	R 1/4	-02MS
		R 3/8	-03MS
		R 1/2	-04MS

Female thread type

Image	Body size	Connection port size	Part no.
		Rc 1/8	KKH3S-01F
	1/8	Rc 1/4	-02F
		Rc 3/8	-03F
		Rc 1/4	KKH4S-02F
	1/4	Rc 3/8	-03F

Nut fitting type (for fiber reinforced urethane hose)

Image	Body size	Applicable hose I.D./O.D. mm	Part no.
		5/8	KKH3S-50N
	1/8	6/9	-60N
		6.5/10	-65N
		5/8	KKH4S-50N
	1/4	6/9	-60N
		6.5/10	-65N
		8/12	-80N
		8.5/12.5	-85N

Series KKH are only available as sockets.
Series KK should be used as plugs.

S Couplers Series *KKH*



JIS Symbol

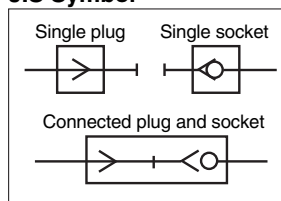

Specifications

Fluid	Air, Water (standard industrial water)
Operating pressure range <small>Note)</small>	KKH3: -90 kPa to 1.0 MPa KKH4: 0 to 1.0 MPa
Proof pressure	1.5 MPa
Ambient and fluid temperature	Air: -5 to 60°C Water: 5 to 40°C (with no freezing)
Plating, Sealant	Electroless nickel plated (copper-free application), With male thread sealant
Connection plug	Series KK plug

Note) Do not use the S couplers with a leak tester or for vacuum retention because they are not guaranteed for zero leakage.

Performance

Plug and socket connection	One-touch connection and release
Check valve	Socket: Built-in check valve (standard)
Sleeve lock mechanism	—

Effective Area

Body size	Plug	Socket	Effective area mm ²
1/8	KK3P-01MS	KKH3S-01MS	20
1/4	KK4P-02MS	KKH4S-02MS	39

The flow characteristics are the same as those of Series KK.
Please refer to page 5.

How to Order

KKH 4 S-02 M S

- Body size**

3	1/8
4	1/4
- Socket/Plug designation**

S	Socket
---	--------
- With sealant (male thread)**
- Connection type**

Symbol	Type
M	Male thread
F	Female thread
N	With nut fitting
- Piping port size variation**

Male/Female thread type		Nut fitting type	
Symbol	Connection port size	Symbol	Hose I.D./O.D. mm
01	R, Rc 1/8	50	5/8
02	R, Rc 1/4	60	6/9
03	R, Rc 3/8	65	6.5/10
04	R, Rc 1/2	80	8/12
		85	8.5/12.5

Note) Please refer to the previous page to confirm the right combination.

Series KKH

Dimensions/Socket (S)

Male thread type

(mm)



Body size	Model	T Connection port size	H Width across flats	øD	L1	L2 When connected	A1*	A2* When connected	Min. bore size	Effective area mm ²	Weight g
1/8	KKH3S-01MS	R 1/8	14	20.2	36,6	39,1	33.5	36.0	6.0	20.4	20.3
	-02MS	R 1/4			37,0	39,5	31.5	34.0	9.0	21.1	19.4
	-03MS	R 3/8	17		37,6	40,1	32.2	34.5	9.0	21.1	27.7
1/4	KKH4S-01MS	R 1/8	19	28.0	49,5	53,2	46.4	50.1	6.0	22.9	48.7
	-02MS	R 1/4			50,5	54,2	45.0	48.7	9.0	38.9	45.3
	-03MS	R 3/8	19		48,9	52,6	43.5	47.2	11.0	40.4	52.1
	-04MS	R 1/2	22		48,8	52,5	41.7	45.4	13.0	42.7	62.4

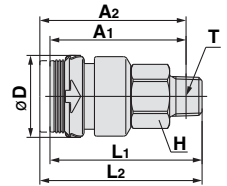

* Reference dimension for R threads after installation.

Female thread type

(mm)



Body size	Model	T Connection port size	H Width across flats	øD	L1	L2 When connected	Min. bore size	Effective area mm ²	Weight g
1/8	KKH3S-01F	Rc 1/8	14	20.2	36.0	38.5	8.2	20.6	23.8
	-02F	Rc 1/4	17		40.1	42.4		21.1	33.1
	-03F	Rc 3/8	19		41.9	44.3	21.1	37.1	
1/4	KKH4S-02F	Rc 1/4	19	28.0	50.4	54.1	10.9	39.6	58.1
	-03F	Rc 3/8			51.1	54.8	14.4	42.7	47.4

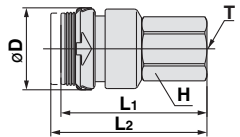

Nut fitting type (for fiber reinforced urethane hose)

(mm)



Body size	Model	Applicable hose I.D./O.D. mm	H1 Width across flats	H2 Width across flats	øD	L1	L2 When connected	M	Min. bore size	Effective area mm ²	Weight g
1/8	KKH3S-50N	5/8	14	14	20.2	42.6	45.1	13.7	4.5	12.2	32.3
	-60N	6/9	17	17		44.4	46.9	16.5	5.4	18.3	48.9
	-65N	6.5/10				5.9	19.2	46.6			
1/4	KKH4S-50N	5/8	19	14	28.0	54.1	57.8	13.7	4.5	12.2	57.0
	-60N	6/9		17		56.8	60.5	16.5	5.4	20.4	70.5
	-65N	6.5/10		17		56.8	60.5	16.5	5.9	24.1	68.0
	-80N	8/12		19		55.4	59.1	17.4	7.4	35.1	69.7
	-85N	8.5/12.5		19		55.4	59.1	17.4	7.8	36.6	72.3

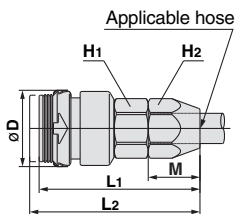

Series KKH are only available as sockets. Series KK should be used as plugs. For dimensions, please refer to page 7.

S Couplers

Series KKA

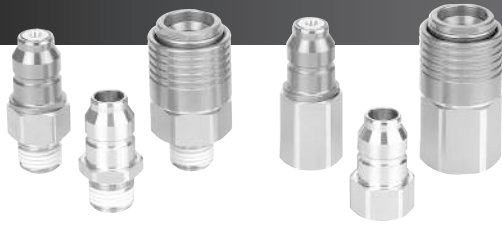

Stainless steel type

NEW

Connection port size 1 to 1 1/2 is newly added.



Series KKA7/8/9

- **Body material: Stainless steel 304**
Seal material: Fluoro rubber (Special FKM)
- **Both plug and socket have an integral check valve.**

Available with and without check valves depending on the operating conditions.

- **Reduces liquid dripping when the plug and socket are uncoupled.**

Liquid dripping: 0.02 to 0.77 cm³ at each removal

Aeration: 0.1 to 2.7 cm³ at each removal

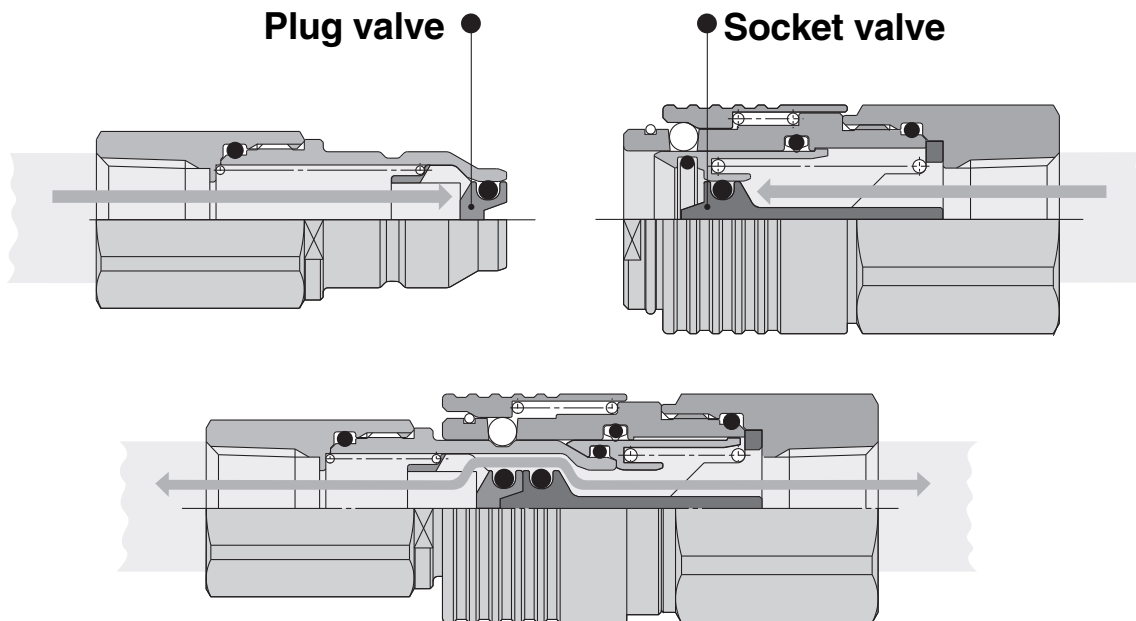

- **Non-greased specification (standard)**

Allows smooth installation and removal even without grease

- O-ring: Fluorine coated
- Sliding parts of plug and socket: Plated with fluorine-contained material

- **Fluid: Water, Air**

- **Operating temperature range: -5 to 150°C**

Note) This product should not be used with steam.

Series KKA

Plug (P)

Male thread type

Body size	Port size	Part no.	
		With check valve	Without check valve
1/8	R 1/8	KKA3P-01M	KKA3P-01M-1
	R 1/4	-02M	-02M-1
	R 3/8	-03M	-03M-1
1/4	R 1/4	KKA4P-02M	KKA4P-02M-1
	R 3/8	-03M	-03M-1
	R 1/2	-04M	-04M-1
1/2	R 3/8	KKA6P-03M	KKA6P-03M-1
	R 1/2	-04M	-04M-1
	R 3/4	-06M	-06M-1
3/4	R 1/2	KKA7P-04M	—
	R 3/4	-06M	—
	R 1	-10M	—
1	R 3/4	KKA8P-06M	—
	R 1	-10M	—
	R 1 1/4	-12M	—
1 1/4	R 1 1/4	-12M	—
	R 1 1/2	-14M	—



With check valve



Without check valve

Socket (S)

Male thread type

Body size	Port size	Part no.	
		With check valve	Without check valve
1/8	R 1/8	KKA3S-01M	KKA3S-01M-1
	R 1/4	-02M	-02M-1
	R 3/8	-03M	-03M-1
1/4	R 1/4	KKA4S-02M	KKA4S-02M-1
	R 3/8	-03M	-03M-1
	R 1/2	-04M	-04M-1
1/2	R 3/8	KKA6S-03M	KKA6S-03M-1
	R 1/2	-04M	-04M-1
	R 3/4	-06M	-06M-1
3/4	R 1/2	KKA7S-04M	—
	R 3/4	-06M	—
	R 1	-10M	—
1	R 3/4	KKA8S-06M	—
	R 1	-10M	—
	R 1 1/4	-12M	—
1 1/4	R 1	KKA9S-10M	—
	R 1 1/4	-12M	—
	R 1 1/2	-14M	—



Female thread type

Body size	Port size	Part no.	
		With check valve	Without check valve
1/8	Rc 1/8	KKA3P-01F	KKA3P-01F-1
	Rc 1/4	-02F	-02F-1
	Rc 3/8	-03F	-03F-1
1/4	Rc 1/4	KKA4P-02F	KKA4P-02F-1
	Rc 3/8	-03F	-03F-1
	Rc 1/2	-04F	-04F-1
1/2	Rc 3/8	KKA6P-03F	KKA6P-03F-1
	Rc 1/2	-04F	-04F-1
	Rc 3/4	-06F	-06F-1
3/4	Rc 1/2	KKA7P-04F	—
	Rc 3/4	-06F	—
	Rc 1	-10F	—
1	Rc 3/4	KKA8P-06F	—
	Rc 1	-10F	—
	Rc 1 1/4	-12F	—
1 1/4	Rc 1	KKA9P-10F	—
	Rc 1 1/4	-12F	—
	Rc 1 1/2	-14F	—



With check valve



Without check valve

Female thread type

Body size	Port size	Part no.	
		With check valve	Without check valve
1/8	Rc 1/8	KKA3S-01F	KKA3S-01F-1
	Rc 1/4	-02F	-02F-1
	Rc 3/8	-03F	-03F-1
1/4	Rc 1/4	KKA4S-02F	KKA4S-02F-1
	Rc 3/8	-03F	-03F-1
	Rc 1/2	-04F	-04F-1
1/2	Rc 3/8	KKA6S-03F	KKA6S-03F-1
	Rc 1/2	-04F	-04F-1
	Rc 3/4	-06F	-06F-1
3/4	Rc 1/2	KKA7S-04F	—
	Rc 3/4	-06F	—
	Rc 1	-10F	—
1	Rc 3/4	KKA8S-06F	—
	Rc 1	-10F	—
	Rc 1 1/4	-12F	—
1 1/4	Rc 1	KKA9S-10F	—
	Rc 1 1/4	-12F	—
	Rc 1 1/2	-14F	—



S Couplers

Series KKA

Stainless steel type



JIS Symbol

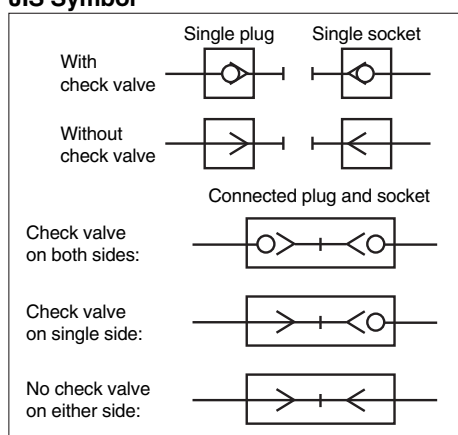

Characteristics with check valve on both sides

Body size	Liquid dripping cm ³ at each removal	Aeration cm ³ at each removal
KKA3	0.02	0.1
KKA4	0.04	0.1
KKA6	0.06	0.2
KKA7	0.14	0.5
KKA8	0.27	0.9
KKA9	0.77	2.7

Liquid dripping:

Volume of water leakage at the time when the plug and socket are uncoupled.

Aeration:

Volume of external air entrained when the plug and socket are connected.

Specifications

Fluid	Water, Air
Operating pressure range	Note) KKA3: -100 kPa to 1.0 MPa KKA4/6/7/8/9: 0 to 1.0 MPa
Proof pressure	10 MPa
Ambient and fluid temperature	-5 to 150°C (with no freezing) Note) This product should not be used with steam.
Non-greased specification	No grease is used. Rubber: Fluorine coated, (Metal sliding parts: Plated with fluorine-contained material)
Material	Metal part: Stainless steel 304, Rubber material: Fluoro rubber (Special FKM)
Seal	With male thread seal

Note) Do not use the S couplers with a leak tester or for vacuum retention because they are not guaranteed for zero leakage.

Performance

Plug and socket connection	One-touch connection and release
Check valve	Check valve on both sides, Without check valve

Note) Series KKA cannot be connected with Series KK or Series KKH.

Effective Area

	Built-in check valve	Plug	Socket	Effective area mm ²
Plug: With check valve Socket: With check valve		KKA3P-01F	KKA3S-01F	17.4
		KKA4P-02F	KKA4S-02F	26.4
		KKA6P-04F	KKA6S-04F	54.2
		KKA7P-06F	KKA7S-06F	99.6
		KKA8P-10F	KKA8S-10F	168.3
		KKA9P-12F	KKA9S-12F	332.1
Plug: Without check valve Socket: With check valve		KKA3P-01M-1	KKA3S-01M	18.5
		KKA4P-02M-1	KKA4S-02M	31.8
		KKA6P-04M-1	KKA6S-04M	55.3
Plug: Without check valve Socket: Without check valve		KKA3P-01M-1	KKA3S-01M-1	22.6
		KKA4P-02M-1	KKA4S-02M-1	40.2
		KKA6P-04M-1	KKA6S-04M-1	76.0

How to Order

KKA 4 P-02 M -1

Body size

3	1/8
4	1/4
6	1/2
7	3/4
8	1
9	1 1/4

Socket/Plug designation

P	Plug
S	Socket

Port size

Symbol	Thread size
01	R, Rc 1/8
02	R, Rc 1/4
03	R, Rc 3/8
04	R, Rc 1/2
06	R, Rc 3/4
10	R, Rc 1
12	R, Rc 1 1/4
14	R, Rc 1 1/2

Built-in check valve

Nil	With check valve
-1	Without check valve

Note) KKA7/8/9 is not available without a check valve. Contact us when such a type is needed.

Connection type

Symbol	Type
M	Male thread (with seal)
F	Female thread

Built-in check valve	Plug	Socket	Availability
	Yes	Yes	○
	No	Yes	○
	No	No	○
	Yes	No	×

Note) A plug with check valve should be used in combination with a socket with check valve.
If a socket without check valve is used, the check valve of the plug will not open.

Note) Please refer to the previous page to confirm the right combination.

Series KKA

Flow Characteristics

Air

Plug: With check valve Socket: With check valve

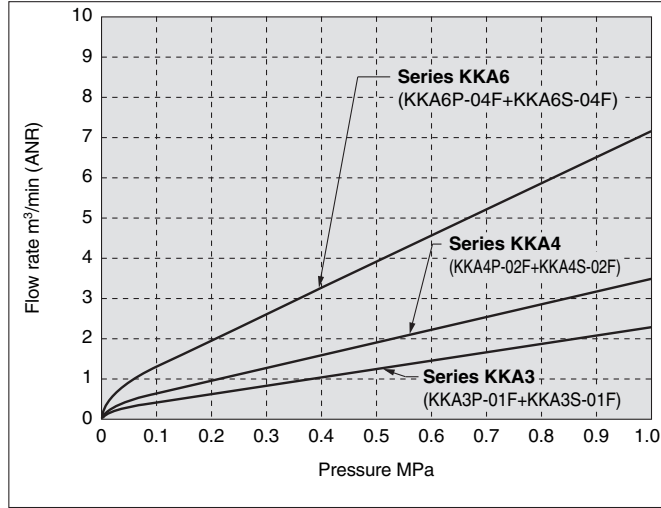

Plug: With check valve Socket: With check valve

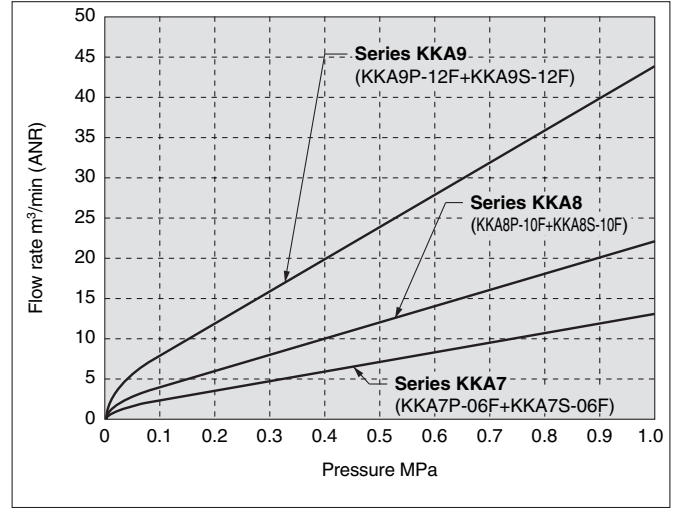

Plug: Without check valve Socket: With check valve

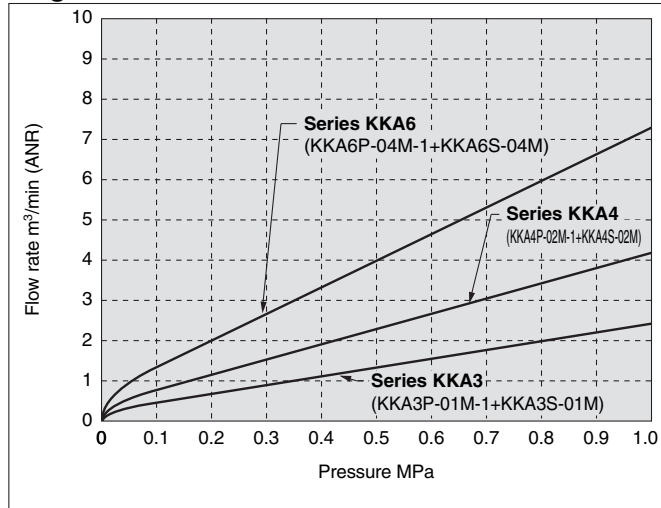

Plug: Without check valve Socket: Without check valve

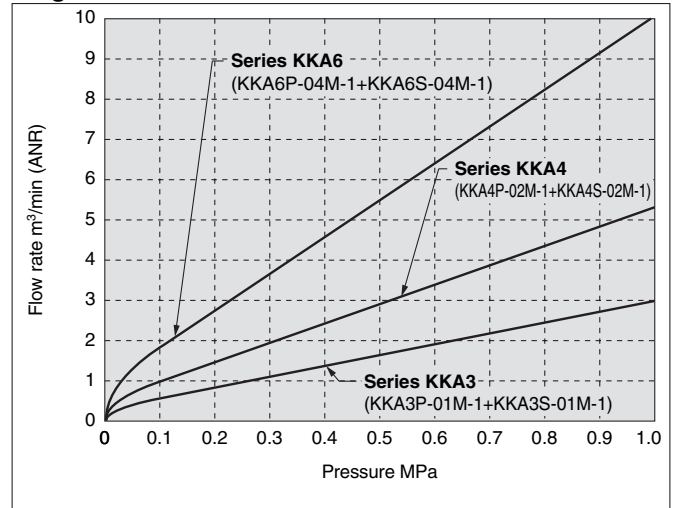

Pressure Loss

Water

Plug: With check valve Socket: With check valve

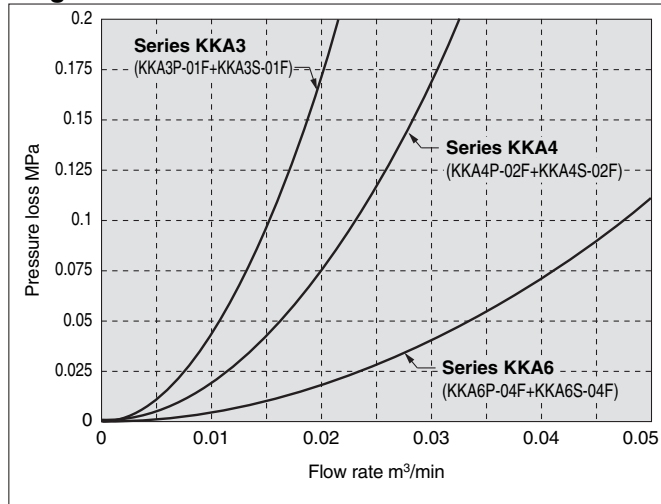

Plug: With check valve Socket: With check valve

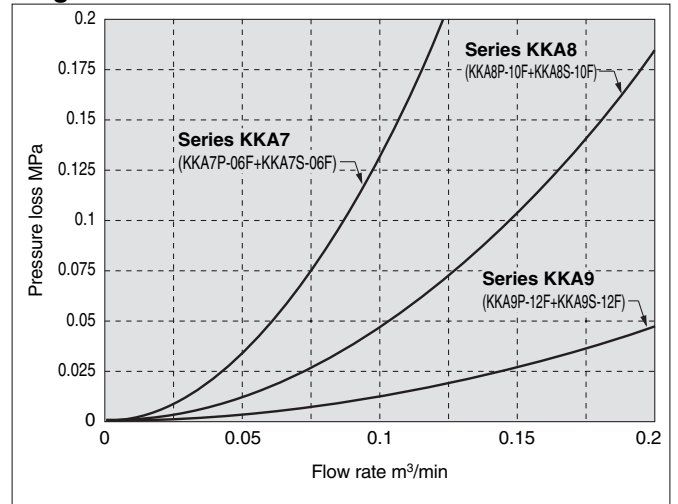

Construction

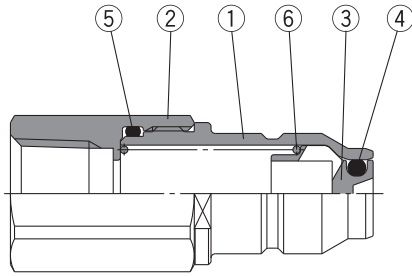

Plug

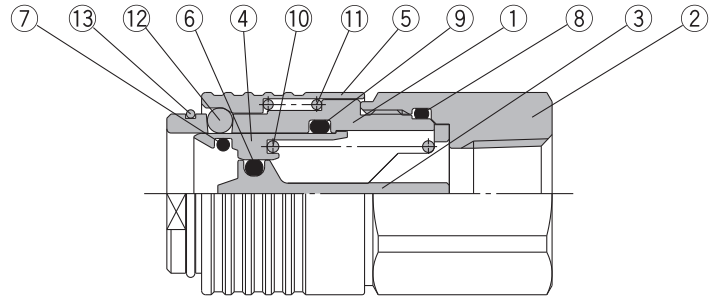

Socket

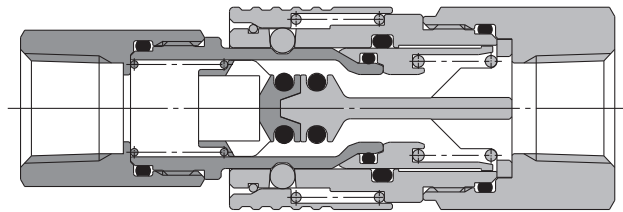

Plug

No.	Description	Material	Note
1	Stem	Stainless steel	Plated with fluorine-contained material
2	Rear stem	Stainless steel	
3	Plug valve	Stainless steel	
4	Valve O-ring	Special FKM	Fluorine coated
5	Stem O-ring	Special FKM	Fluorine coated
6	Plug valve spring	Stainless steel	

Socket

No.	Description	Material	Note
1	Body	Stainless steel	Plated with fluorine-contained material
2	Rear body	Stainless steel	
3	Socket valve	Stainless steel	
4	Collar	Stainless steel	Plated with fluorine-contained material
5	Sleeve	Stainless steel	Plated with fluorine-contained material
6	Valve O-ring	Special FKM	Fluorine coated
7	Plug O-ring	Special FKM	Fluorine coated
8	Body O-ring	Special FKM	Fluorine coated
9	Collar seal	Special FKM	Fluorine coated
10	Collar spring	Stainless steel	
11	Sleeve spring	Stainless steel	
12	Steel ball	Stainless steel	
13	Stopper ring	Stainless steel	

KKA Series Spare Parts

Description	Part no.	No.
Plug O-ring	KKA3S-P01	Socket ⑦
	KKA4S-P01	
	KKA6S-P01	
	KKA7S-P01	
	KKA8S-P01	
	KKA9S-P01	

Series KKA

Dimensions/Plug (P)

With check valve

Male thread type

(mm)



Body size	Model	T Connection port size	H Width across flats	L1	L2	A	Min. bore size	Effective area mm ²	Weight g
1/8	KKA3P-01M	R 1/8	14	35.4	16.0	31.4	5.6	17.4	15.4
	-02M	R 1/4		38.4		32.4			19.8
	-03M	R 3/8		39.4		32.9			32.9
1/4	KKA4P-02M	R 1/4	17	42.2	18.9	36.2	6.9	26.4	28.3
	-03M	R 3/8	43.2	36.7		36.6			
	-04M	R 1/2	22	46.2		38.2			65.9
1/2	KKA6P-03M	R 3/8	24	47.1	20.4	40.6	10.0	54.2	60.3
	-04M	R 1/2		47.9		39.9			69.2
	-06M	R 3/4		30		49.9			40.4
3/4	KKA7P-04M	R 1/2	32	66.3	27.6	58.1	13.5	99.6	173.9
	-06M	R 3/4		69.4		59.9			209.6
	-10M	R 1		36		69.9			59.5
1	KKA8P-06M	R 3/4	41	82.9	35.6	73.4	17.5	168.3	362.8
	-10M	R 1		85.4		75.0			403.9
	-12M	R 1 1/4		46		85.4			72.7
1 1/4	KKA9P-10M	R 1	55	109.5	49.1	99.1	22.0	264.9	824.1
	-12M	R 1 1/4		109.0		96.3			861.4
	-14M	R 1 1/2		109.0		96.3			332.1

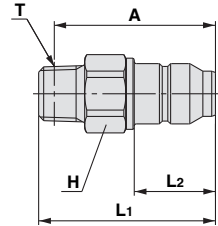

Female thread type

(mm)



Body size	Model	T Connection port size	H Width across flats	L1	L2	Min. bore size	Effective area mm ²	Weight g
1/8	KKA3P-01F	Rc 1/8	14	36.0	16.0	5.6	17.4	20.2
	-02F	Rc 1/4	17	39.6				31.8
	-03F	Rc 3/8	19	40.4				35.8
1/4	KKA4P-02F	Rc 1/4	17	43.4	18.9	6.9	26.4	36.1
	-03F	Rc 3/8	19	44.4				40.2
	-04F	Rc 1/2	24	48.6				69.7
1/2	KKA6P-03F	Rc 3/8	24	48.7	20.4	10.0	54.2	84.1
	-04F	Rc 1/2		52.9				79.7
	-06F	Rc 3/4		30				54.6
3/4	KKA7P-04F	Rc 1/2	32	67.7	27.6	13.5	99.6	217.1
	-06F	Rc 3/4		69.4				196.8
	-10F	Rc 1		72.4				325.9
1	KKA8P-06F	Rc 3/4	41	82.0	35.6	17.5	168.3	420.5
	-10F	Rc 1		85.0				391.3
	-12F	Rc 1 1/4		50				87.3
1 1/4	KKA9P-10F	Rc 1	55	107.8	49.1	24.6	332.1	986.9
	-12F	Rc 1 1/4		110.1				925.6
	-14F	Rc 1 1/2		110.1				848.2

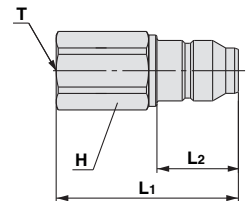

Dimensions/Socket (S)

With check valve

Male thread type

(mm)



Body size	Model	T Connection port size	H Width across flats	øD	L	A	Min. bore size	Effective area mm ²	Weight g
1/8	KKA3S-01M	R 1/8	17	18.5	38.1	34.1	5.9	18.5	38.5
	-02M	R 1/4			41.1	35.1			41.8
	-03M	R 3/8			42.1	35.6			46.3
1/4	KKA4S-02M	R 1/4	22	24.2	46.0	40.0	7.7	31.8	76.8
	-03M	R 3/8			47.0	40.5			78.5
	-04M	R 1/2			50.0	42.0			86.6
1/2	KKA6S-03M	R 3/8	30	30.7	51.4	44.9	10.2	55.3	149.1
	-04M	R 1/2			54.4	46.4			160.4
	-06M	R 3/4			56.4	46.9			184.8
3/4	KKA7S-04M	R 1/2	36	42.5	76.3	68.1	13.6	101.5	426.1
	-06M	R 3/4			79.3	69.8			457.8
	-10M	R 1			82.8	72.4			514.0
1	KKA8S-06M	R 3/4	46	55	94.9	85.4	17.6	169.9	873.5
	-10M	R 1			98.4	88.0			931.1
	-12M	R 1 1/4			100.4	87.7			1012.9
1 1/4	KKA9S-10M	R 1	63	69	125.5	115.1	22.0	264.9	1680.7
	-12M	R 1 1/4			127.5	114.8			1758.1
	-14M	R 1 1/2			127.5	114.8	25.1	344.9	1819.4

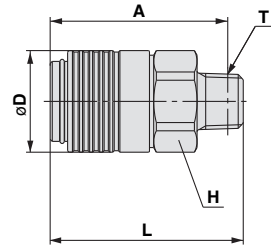

Female thread type

(mm)



Body size	Model	T Connection port size	H Width across flats	øD	L	Min. bore size	Effective area mm ²	Weight g
1/8	KKA3S-01F	Rc 1/8	17	18.5	37.6	5.9	18.5	46.9
	-02F	Rc 1/4			41.2			47.2
	-03F	Rc 3/8			43.1			52.3
1/4	KKA4S-02F	Rc 1/4	22	24.2	46.1	7.7	31.8	97.1
	-03F	Rc 3/8			46.9			91.1
	-04F	Rc 1/2			52.3			104.3
1/2	KKA6S-03F	Rc 3/8	30	30.7	50.5	10.2	55.3	189.6
	-04F	Rc 1/2			56.2			202.0
	-06F	Rc 3/4			57.9			180.6
3/4	KKA7S-04F	Rc 1/2	36	42.5	75.1	13.6	101.5	477.2
	-06F	Rc 3/4			76.5			457.4
	-10F	Rc 1			82.3			550.9
1	KKA8S-06F	Rc 3/4	46	55	90.9	17.6	169.9	935.2
	-10F	Rc 1			93.9			914.7
	-12F	Rc 1 1/4			99.2			1002.1
1 1/4	KKA9S-10F	Rc 1	63	69	121.8	25.1	344.9	1919.1
	-12F	Rc 1 1/4			121.8			1810.0
	-14F	Rc 1 1/2			121.8			1732.6

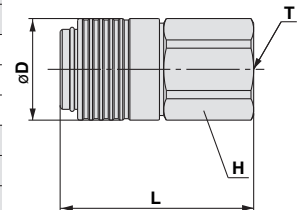

Series KKA

Dimensions/Plug (P)

Without check valve

Male thread type

(mm)



Body size	Model	T Connection port size	H Width across flats	L1	L2	A	Min. bore size	Effective area mm ²	Weight g
1/8	KKA3P-01M-1	R 1/8	12	28.5	16.0	24.5	6.0	22.6	9.8
	-02M-1	R 1/4	14	31.5		25.5			14.6
	-03M-1	R 3/8	17	32.5		26.0			23.6
1/4	KKA4P-02M-1	R 1/4	17	34.4	18.9	28.4	8.0	40.2	21.0
	-03M-1	R 3/8		35.4		28.9			27.9
	-04M-1	R 1/2		39.4		31.4			50.2
1/2	KKA6P-03M-1	R 3/8	22	37.9	20.4	31.4	11.0	76.0	41.9
	-04M-1	R 1/2		40.9		32.9			56.0
	-06M-1	R 3/4		42.9		33.4			98.7

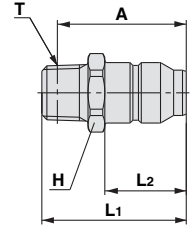

Female thread type

(mm)



Body size	Model	T Connection port size	H Width across flats	L1	L2	Min. bore size	Effective area mm ²	Weight g	
1/8	KKA3P-01F-1	Rc 1/8	14	23.2	16.0	6.0	22.6	9.6	
	-02F-1	Rc 1/4	17	30.3				20.2	
	-03F-1	Rc 3/8	19	32.0				26.2	
1/4	KKA4P-02F-1	Rc 1/4	17	29.7	18.9	8.0	40.2	20.0	
	-03F-1	Rc 3/8		19				34.0	25.8
	-04F-1	Rc 1/2		24				39.4	46.1
1/2	KKA6P-03F-1	Rc 3/8	22	30.9	20.4	11.0	76.0	34.3	
	-04F-1	Rc 1/2		24				39.6	50.0
	-06F-1	Rc 3/4		30				42.8	78.6

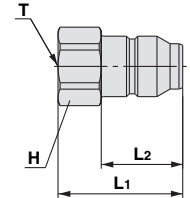

Dimensions/Socket (S)

Without check valve

Male thread type

(mm)



Body size	Model	T Connection port size	H Width across flats	øD	L	A	Min. bore size	Effective area mm ²	Weight g
1/8	KKA3S-01M-1	R 1/8	17	18.5	38.1	34.1	6.1	23.4	36.1
	-02M-1	R 1/4			41.1	35.1			39.4
	-03M-1	R 3/8			42.1	35.6			43.9
1/4	KKA4S-02M-1	R 1/4	22	24.2	46.0	40.0	8.1	41.2	71.9
	-03M-1	R 3/8			47.0	40.5			73.6
	-04M-1	R 1/2			50.0	42.0			81.7
1/2	KKA6S-03M-1	R 3/8	30	30.7	51.4	44.9	11.4	81.6	138.3
	-04M-1	R 1/2			54.4	46.4			149.6
	-06M-1	R 3/4			56.4	46.9			174.0

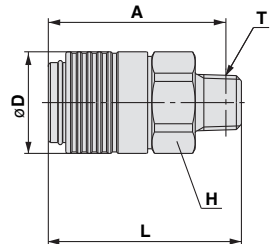

Female thread type

(mm)



Body size	Model	T Connection port size	H Width across flats	øD	L	Min. bore size	Effective area mm ²	Weight g
1/8	KKA3S-01F-1	Rc 1/8	17	18.5	37.6	6.1	23.4	44.5
	-02F-1	Rc 1/4			41.2			44.8
	-03F-1	Rc 3/8			43.1			49.9
1/4	KKA4S-02F-1	Rc 1/4	22	24.2	46.1	8.1	41.2	92.2
	-03F-1	Rc 3/8			46.9			86.2
	-04F-1	Rc 1/2			52.3			99.4
1/2	KKA6S-03F-1	Rc 3/8	30	30.7	50.5	11.4	81.6	178.8
	-04F-1	Rc 1/2			56.2			191.2
	-06F-1	Rc 3/4			57.9			169.8

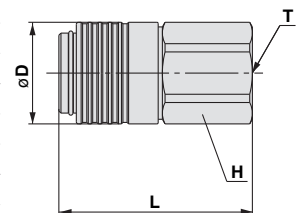



S Couplers

Series KK13

Manufactured by RECTUS AG



● One-touch connection

- Can be connected by simply pushing the plug into the socket.
- Manipulation with one hand improves work efficiency.

● Flow is possible from the plug side or socket side.

● O-ring seal construction for outstanding air tightness and durability.

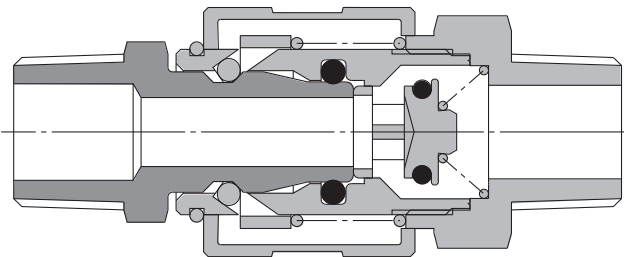

Plug (P)

Male thread type

	Port size	Part no.
	R 1/8	KK13P-01M
	R 1/4	-02M
	R 3/8	-03M
	R 1/2	-04M

Female thread type

	Port size	Part no.
	Rc 1/4	KK13P-02F
	Rc 3/8	-03F
	Rc 1/2	-04F
	G 1/4	-G02F

Barb fitting type

	Applicable hose I.D.	Part no.
	1/4"	KK13P-07B
	1/4"	-09B
	3/8"	-11B
	1/2"	-13B

Nut fitting type (for fiber reinforced urethane hose)

	Applicable hose I.D./O.D.	Part no.
	5/8	KK13P-50N
	6/9	-60N
	6.5/10	-65N
	8/12	-80N
	8.5/12.5	-85N
	11/16	-110N

Socket (S)

Male thread type

	Port size	Part no.
	R 1/8	KK13S-01M
	R 1/4	-02M
	R 3/8	-03M
	R 1/2	-04M

Female thread type

	Port size	Part no.
	Rc 1/4	KK13S-02F
	Rc 3/8	-03F
	Rc 1/2	-04F

Barb fitting type

	Applicable hose I.D.	Part no.
	1/4"	KK13S-07B
	1/4"	-09B
	3/8"	-11B
	1/2"	-13B

Nut fitting type (for fiber reinforced urethane hose)

	Applicable hose I.D./O.D.	Part no.
	5/8	KK13S-50N
	6/9	-60N
	6.5/10	-65N
	8/12	-80N
	8.5/12.5	-85N
	11/16	-110N

S Couplers

Series *KK13*

Manufactured by RECTUS AG



Specifications

Fluid	Air (Note)
Operating pressure range	0 to 1.5 MPa
Proof pressure	2 MPa
Ambient and fluid temperature	-5 to 60°C
Plating	Nickel plated external metal parts

Note) Cannot be used with water.

Performance

Plug and socket connection	One-touch connection and release
Check valve	Socket: Built-in check valve (standard)

Effective Area

Body size	Plug	Socket	Effective area mm ²
1/4	KK13P-02M	KK13S-02M	24.1
	KK13P-03M	KK13S-03M	31.1

JIS Symbol

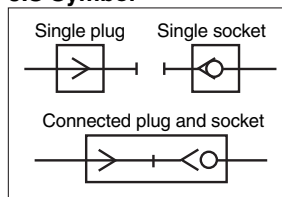

How to Order

KK 13 S - 02 M

Series 13

Connection type

M	Male thread
F	Female thread
B	With barb fitting
N	With nut fitting

Socket/Plug designation

S	Socket
P	Plug

Port size variation

Male/Female thread type	
Symbol	Thread size
01	R, Rc 1/8
02	R, Rc 1/4
03	R, Rc 3/8
04	R, Rc 1/2
G02	G 1/4

Barb fitting type	
Symbol	Hose I.D.
07	6(1/4")
09	8(1/4")
11	9(3/8")
13	12(1/2")

Nut fitting type	
Symbol	Applicable hose I.D./O.D.
50	5/8
60	6/9
65	6.5/10
80	8/12
85	8.5/12.5
110	11/16

Note) Please refer to the previous page to confirm the right combination.

Flow Characteristics

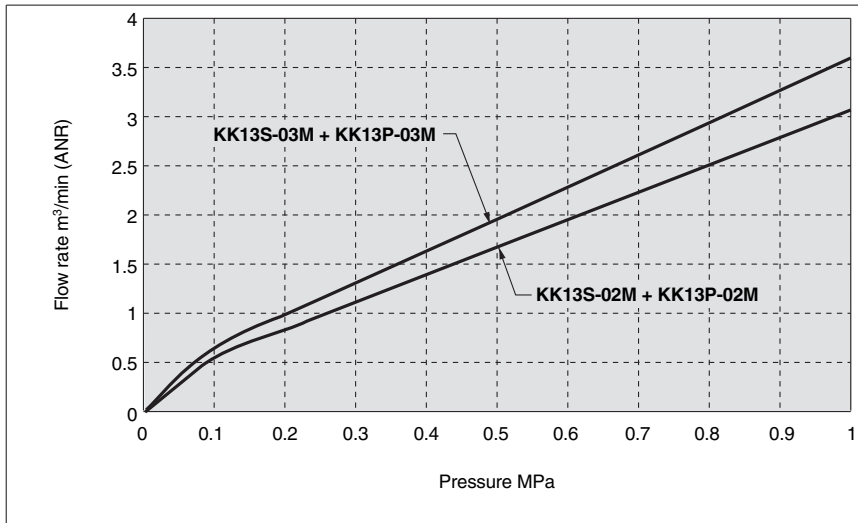

Construction

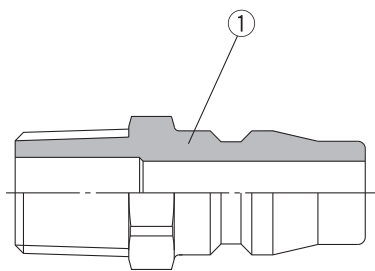

Plug

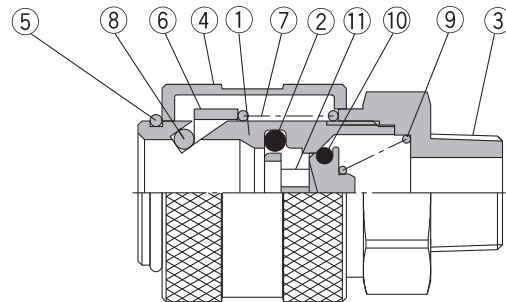

Socket

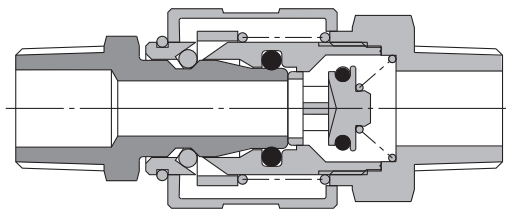

Plug

No.	Description	Material	Note
1	Stem	Steel	Nickel plated

Socket

No.	Description	Material	Note
1	Coupling body	Brass	Nickel plated
2	Plug O-ring	NBR	
3	Body	Brass	Nickel plated
4	Sleeve	Brass	Nickel plated
5	Snap ring	Stainless steel	
6	Collar	Brass	
7	Sleeve spring	Stainless steel	
8	Locking pin	Stainless steel	
9	Valve spring	Stainless steel	
10	Valve O-ring	NBR	
11	Valve	Brass	

Series KK13

Dimensions

Plug (P)

Male thread type

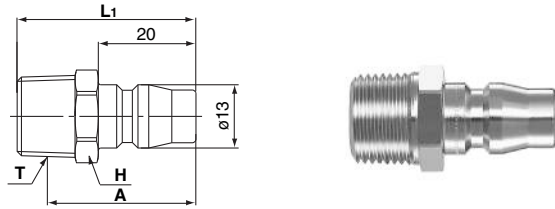

Model	T Connection male threads	H Width across flats	L ₁	A*	Min. bore size	Effective area mm ²	Weight g
KK13P-01M	R 1/8	14	34.0	30.0	6.0	22.6	18
-02M	R 1/4		37.0	31.0			22
-03M	R 3/8	17	44.0	30.6	7.5	35.3	27
-04M	R 1/2	22		35.8			51

* Reference dimension after installation.

Female thread type

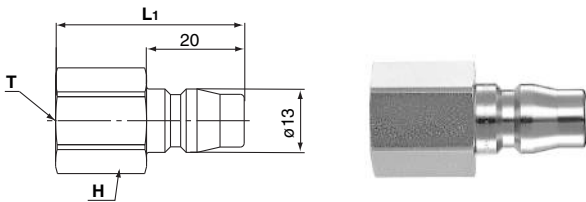

Model	T Connection female threads	H Width across flats	L ₁	Min. bore size	Effective area mm ²	Weight g
KK13P-02F	Rc 1/4	17	35.5	7.5	35.3	27
-03F	Rc 3/8	19	39.0			32
-04F	Rc 1/4	24	42.5			51
-G02F	G 1/4	17	32.0			27

Barb fitting type (for rubber hose)

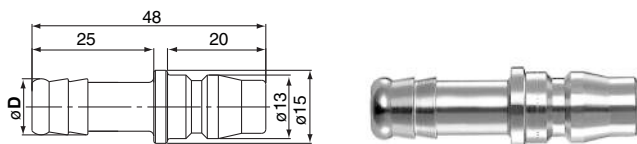

Model	Hose I.D.	øD	Min. bore size	Effective area mm ²	Weight g
KK13P-07B	6(1/4")	7.5	4.1	10.6	17
-09B	8(1/4")	9.4	6.0	22.6	18
-11B	9(3/8")	11.5	7.5	35.3	21
-13B	12(1/2")	14.5			25

Refer to page 9 for calculation of the connected plug and socket dimension.

Socket (S)

Male thread type

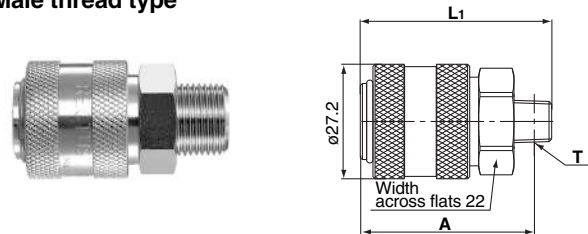

Model	T Connection male threads	L ₁	A*	Min. bore size	Effective area mm ²	Weight g
KK13S-01M	R 1/8	45.5	41.5	6.0	19.0	81
-02M	R 1/4	48.5	42.5	7.0	24.1	86
-03M	R 3/8	53.0	42.1	10.2	31.1	89
-04M	R 1/2		44.8		32.1	108

* Reference dimension after installation.

Female thread type

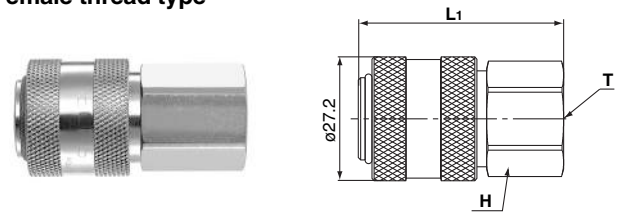

Model	T Connection female threads	H Width across flats	L ₁	Min. bore size	Effective area mm ²	Weight g
KK13S-02F	Rc 1/4	22	47.0	10.5	25.7	103
-03F	Rc 3/8		52.0	10.2	31.1	107
-04F	Rc 1/2	24	55.5		32.1	117

Barb fitting type (for rubber hose)

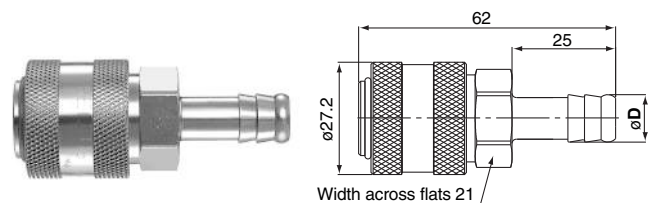

Model	Hose I.D.	øD	Min. bore size	Effective area mm ²	Weight g
KK13S-07B	6(1/4")	7.5	4.1	8.0	81
-09B	8(1/4")	9.5	6.0	16.1	83
-11B	9(3/8")	11.5	8.0	25.4	88
-13B	12(1/2")	14.5	10.2	31.9	

Dimensions

Plug (P)

Nut fitting type (for fiber reinforced urethane hose)

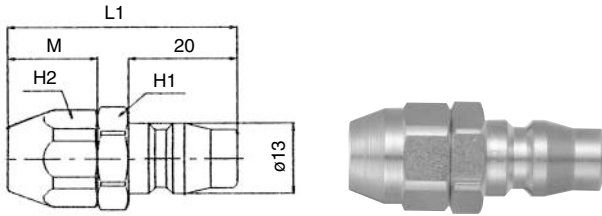

(mm)

Model	Applicable hose I.D./O.D.	H1 Width across flats	H2 Width across flats	L1	M	Effective area mm ²	Weight g
KK13P-50N	5/8					10.6	
-60N	6/9	17	17	43.0	17.0	16.3	42
-65N	6.5/10						
-80N	8/12						
-85N	8.5/12.5	19	19	45.0	19.0	28.5	52
-110N	11/16	23	23	52.0	23.0	30.9	98

Socket (S)

Nut fitting type (for fiber reinforced urethane hose)

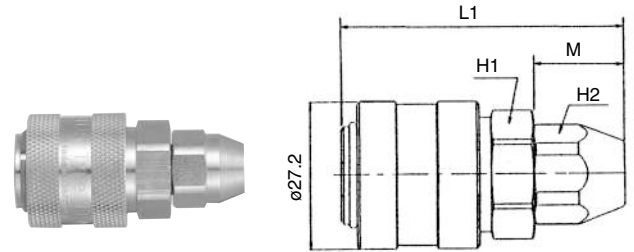

(mm)

Model	Applicable hose I.D./O.D.	H1 Width across flats	H2 Width across flats	L1	M	Effective area mm ²	Weight g
KK13S-50N	5/8					8.5	
-60N	6/9		17	53.2	17.0	14.0	98
-65N	6.5/10	21					
-80N	8/12						
-85N	8.5/12.5		19	55.2	19.0	22.9	105
-110N	11/16	24	23	59.2	23.0	25.0	142



Series *KK/KKH/KKA/KK13* Safety Instructions

These safety instructions are intended to prevent a hazardous situation and/or equipment damage. These instructions indicate the level of potential hazard by a label of "**Caution**", "**Warning**" or "**Danger**". To ensure safety, be sure to observe ISO 4414 Note 1), JIS B 8370 Note 2) and other safety practices.

 **Caution** : Operator error could result in injury or equipment damage.

 **Warning** : Operator error could result in serious injury or loss of life.

 **Danger** : In extreme conditions, there is a possible result of serious injury or loss of life.

Note 1) ISO 4414: Pneumatic fluid power -- General rules relating to systems.

Note 2) JIS B 8370: General Rules for Pneumatic Equipment

Warning

1. The compatibility of pneumatic equipment is the responsibility of the person who designs the pneumatic system or decides its specifications.

Since the products specified here are used in various operating conditions, their compatibility for the specific pneumatic system must be based on specifications or after analysis and/or tests to meet your specific requirements.

2. Only trained personnel should operate pneumatically operated machinery and equipment.

Compressed air can be dangerous if handled incorrectly. Assembly, handling or repair of pneumatic systems should be performed by trained and experienced operators.

3. Do not service machinery/equipment or attempt to remove components until safety is confirmed.

1. Inspection and maintenance of machinery/equipment should only be performed after confirmation of safe locked-out control positions.
2. When equipment is to be removed, confirm the safety process as mentioned above. Cut the supply pressure for this equipment and exhaust all residual compressed air in the system.
3. Before machinery/equipment is restarted, take measures to prevent shooting-out of cylinder piston rod, etc. (Bleed air into the system gradually to create back pressure.)

4. Contact SMC if the product is to be used in any of the following conditions:

1. Conditions and environments beyond the given specifications, or if product is used outdoors.
2. Installation on equipment in conjunction with atomic energy, railway, air navigation, vehicles, medical equipment, food and beverages, recreation equipment, emergency stop circuits, press applications, or safety equipment.
3. An application which has the possibility of having negative effects on people, property, or animals, requiring special safety analysis.



S Couplers Common Precautions 1

Be sure to read before handling.

Selection

Warning

1. Cannot be used as a stop valve that requires zero leakage. A certain amount of leakage is allowed during operation.
2. Series KK and Series KKH cannot be connected with Series KKA. Also, SMC's S coupler cannot be connected with quick couplers of other brands.
This will cause leakage, damage, and disconnection of the plug.
With series KK13, manufactured by RECTUS AG, verify the manufacturer of applicable couplers before use.
3. Do not couple or uncouple the S coupler during pressurisation or while residual pressure remains. The coupler may shoot out under the influence of the pressure.
4. Never apply pressure to an S coupler without check valve when it is uncoupled. The piping may move violently and cause danger.
5. An S coupler without check valve experiences leakage of fluid inside piping when it is uncoupled. Pay special attention in using fluid that can cause danger such as fluid of a high temperature and pressure. Additional use of a stop valve is recommended.
6. The S coupler is heated when used at a high temperature. Take precautions not to touch it since touching it can cause burns.

Caution

1. For a plug and socket connection, select a plug and socket with the same body size. If their body sizes are different, they cannot be connected. This will cause leakage, damage, and disconnection of the plug.
2. Do not use in locations where the connecting threads and tubing connection will slide or rotate. The connecting threads and tubing connection will come apart under these conditions.
3. Use tubing at or above the minimum bending radius. Using below the minimum bending radius can cause breakage or flattening of the tube.
4. Do not use couplers with flammable, explosive, or toxic substances, such as gas, gas fuel, and refrigerant. They may leak from inside the tubing to the outside.
5. Can be used with standard industrial water. When using with other liquids, consult with SMC.
Also, operate with a surge pressure of no more than the maximum operating pressure. If the surge pressure exceeds the maximum operating pressure, it will cause damage to couplers and tubing.
6. Do not use the S coupler with steam. Corrosion of the metal material and deterioration of the sealing material

Mounting

Warning

1. Do not use couplers where rotation normally occurs. The couplers may be damaged.
2. Avoid applications in which vibration or shock is directly applied to the fittings.
3. Fittings with sleeve lock mechanism must be locked during operation in order to prevent sudden disconnection.
4. Install a stop valve at the supply pressure side of the socket. Emergency shutdown may not be possible without it.

Caution

1. Before mounting confirm the model and size, etc. Also, confirm that there are no blemishes, nicks or cracks in the product.
2. When connecting a tube, consider factors such as changes in the tubing length due to pressure, and allow sufficient leeway.
3. Mount so that couplers and tubing are not subjected to twisting, pulling or moment loads. This can cause damage to couplers and flattening, bursting or disconnection of tubing, etc.
4. Mount so that tubing is not damaged due to tangling and abrasion. This can cause flattening, bursting or disconnection of tubing, etc.

Operating Environment

Warning

1. Do not use in locations where static electric charges will be a problem. Consult with SMC regarding use in this kind of environment.
2. Do not use in locations where spatter occurs.
There is a danger of spatter causing a fire. Consult with SMC regarding use in this kind of environment.
3. Do not use in environments where there is direct contact with liquids such as cutting oil, lubricating oil or coolant oil, etc. Contact SMC regarding use in environments where there will be direct contact with cutting oil, lubricating oil or coolant oil, etc.

Maintenance

Caution

1. Check for the following during regular maintenance, and replace components as necessary.
 - a) Scratches, gouges, abrasion, corrosion
 - b) Leakage
 - c) Twisting, flattening or distortion of tubing
 - d) Hardening, deterioration or softness of tubing
2. Do not repair or patch the replaced tubing or couplers for reuse.
3. Do not disassemble the S coupler. Spare parts are not available for this product.



S Couplers Common Precautions 2

Be sure to read before handling.

Handling

⚠ Caution

1. When connecting the plug, hold the plug securely. The plug may be uncoupled due to reaction at the time of connection.
2. When connecting a plug, insert it securely until a click sound is heard from the socket. After the connection, gently pull the plug to see whether it will release. If not securely inserted, the plug may pop out due to the pressure. Also, do not touch the sleeve until the plug is securely inserted. Otherwise, it may lead to a malfunction.
3. When connecting the plug, insert it straight into the socket. If not inserted straight, the socket and/or plug may be damaged or cause a malfunction.
4. When releasing the plug, hold it securely. The connection pipe may move due to reacting stress and/or residual pressure on the plug side.
5. Do not press the inside of the socket with an incompatible plug and/or with a stick. The internal fluid may be ejected and cause a dangerous situation. Also, the ejecting internal fluid may cause the sealings to come apart resulting in the product not functioning.

Plug Insertion Force in Pressurised Condition

Insertion Force of Series KK

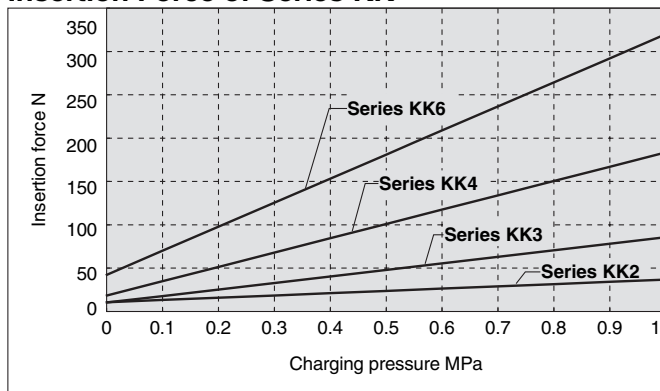

Insertion Force of Series KKA

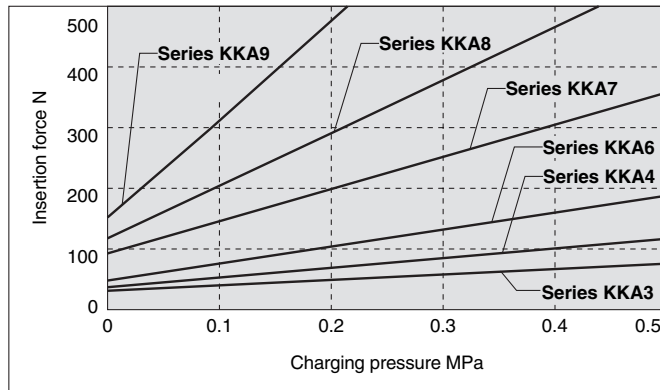

Handling of One-touch Fittings

⚠ Caution

1. Tube attachment/detachment for One-touch fittings
 - 1) Attaching of tubing
 - (1) Take a tube having no flaws on its periphery and cut it off at a right angle. When cutting the tubing, use tubing cutters TK-1, 2 or 3. Do not use pinchers, nippers or scissors, etc. If cutting is done with tools other than tubing cutters, the tubing may be cut diagonally or become flattened, etc. This can make a secure installation impossible, and cause problems such as the tubing pulling out after installation or air leakage. Allow some extra length in the tubing.
 - (2) Grasp the tubing and push it in slowly, inserting it securely all the way into the fitting.
 - (3) After inserting the tubing, pull on it lightly to confirm that it will not come out. If it is not installed securely all the way into the fitting, this can cause problems such as air leakage or the tubing pulling out.
 - 2) Detaching of tubing
 - (1) Push in the release bushing sufficiently. When doing this, push the collar evenly.
 - (2) Pull out the tubing while holding down the release bushing so that it does not come out. If the release bushing is not pressed down sufficiently, there will be increased bite on the tubing and it will become more difficult to pull it out.
 - (3) When the removed tubing is to be used again, cut off the portion which has been chewed before reusing it. If the chewed portion of the tubing is used as is, this can cause trouble such as air leakage or difficulty in removing the tubing.



S Couplers Common Precautions 3

Be sure to read before handling.

Handling of Barb Fittings and Nut Fittings

⚠ Caution

1. When using a nut fitting, insert the hose all the way to the end and securely tighten it with the nut. When the insertion of the hose or the tightening of the nut are not sufficient, the hose may slip out.
2. Disconnection may occur depending on the material or the O.D. accuracy of the hose; therefore be sure to confirm the applicability of the hose.

Handling of Fittings

⚠ Caution

1. Tightening of the M5-size fittings
 - 1) Tighten the fittings with a proper tightening torque range of from 1 to 1.5 N·m. As a rule, after hand tightening, tighten an additional 1/6 turn with a tool
 - 2) Over tightening can cause damage to the threads and/or air leakage due to deformation of the gasket.
 - 3) Insufficient tightening can cause the threads to loosen and/or air to leak out.
2. Tightening of the fittings with a sealant
 - 1) Tighten fittings with sealant using the proper tightening torques in the table below. As a rule, they should be tightened 2 to 3 turns with a tool after first tightening by hand.

Connection thread size	Proper tightening torque N·m
NPT, R1/8	7 to 9
NPT, R1/4	12 to 14
NPT, R3/8	22 to 24
NPT, R1/2	28 to 30
NPT, R3/4	28 to 30
NPT, R1	36 to 38
NPT, R1 1/4	40 to 42
NPT, R1 1/2	48 to 50

- 2) When a fitting is over tightened, more of the sealant material is squeezed out. Remove the squeezed out sealant material.
- 3) When tightening is not sufficient, it will cause sealant failure or a loose fitting.
- 4) Re-using
 - (1) Normally, a fitting with sealant can be re-used 2 to 3 times.
 - (2) Remove the sealant material that is separated and adhering to a removed fitting with air blow, etc. If the separated sealant enters into nearby equipment, it will cause air leakage or malfunction.
 - (3) When the sealant is no longer effective, wrap sealant tape over the sealant material and re-use the fitting. Do not use a sealant material other than sealant tape.
- 5) In cases where positioning is required, turning the fitting in the reverse direction after tightening will cause air leakage.

Precautions on Other Tubing Brands

⚠ Caution

- 1) When using tubing brands other than SMC, confirm that the tubing outside diameter tolerances satisfy the following specifications.
 - (1) Nylon tubing within 0.1 mm
 - (2) Soft nylon tubing within 0.1 mm
 - (3) Polyurethane tubing within +0.15 mm
within -0.2 mm

Do not use tubing if the outside diameter tolerance is not satisfied. It may not be possible to connect the tubing, or leakage or disconnection may occur after connection.



EUROPEAN SUBSIDIARIES:



Austria

SMC Pneumatik GmbH (Austria).
Girakstrasse 8, A-2100 Korneuburg
Phone: +43 2262-62280, Fax: +43 2262-62285
E-mail: office@smc.at
http://www.smc.at



France

SMC Pneumatique, S.A.
1, Boulevard de Strasbourg, Parc Gustave Eiffel
Bussy Saint Georges F-77607 Marne La Vallée Cedex 3
Phone: +33 (0)1-6476 1000, Fax: +33 (0)1-6476 1010
E-mail: contact@smc-france.fr
http://www.smc-france.fr



Netherlands

SMC Pneumatics BV
De Ruyterkade 120, NL-1011 AB Amsterdam
Phone: +31 (0)20-5318888, Fax: +31 (0)20-5318880
E-mail: info@smcpneumatics.nl
http://www.smcpneumatics.nl



Spain

SMC España, S.A.
Zuazobidea 14, 01015 Vitoria
Phone: +34 945-184 100, Fax: +34 945-184 124
E-mail: post@smc.smces.es
http://www.smces.es



Belgium

SMC Pneumatics N.V./S.A.
Nijverheidsstraat 20, B-2160 Wommelgem
Phone: +32 (0)3-355-1464, Fax: +32 (0)3-355-1466
E-mail: post@smcpneumatics.be
http://www.smcpneumatics.be



Germany

SMC Pneumatik GmbH
Boschring 13-15, D-63329 Egelsbach
Phone: +49 (0)6103-4020, Fax: +49 (0)6103-402139
E-mail: info@smc-pneumatik.de
http://www.smc-pneumatik.de



Norway

SMC Pneumatics Norway A/S
Vollsveien 13 C, Granfos Næringspark N-1366 Lysaker
Tel: +47 67 12 90 20, Fax: +47 67 12 90 21
E-mail: post@smc-norge.no
http://www.smc-norge.no



Sweden

SMC Pneumatics Sweden AB
Ekhagsvägen 29-31, S-141 71 Huddinge
Phone: +46 (0)8-603 12 00, Fax: +46 (0)8-603 12 90
E-mail: post@smcpneumatics.se
http://www.smc.nu



Bulgaria

SMC Industrial Automation Bulgaria EOOD
16 Kliment Ohridski Blvd., fl.13 BG-1756 Sofia
Phone: +359 2 9744492, Fax: +359 2 9744519
E-mail: office@smc.bg
http://www.smc.bg



Greece

S. Parianopoulos S.A.
7, Konstantinoupoleos Street, GR-11855 Athens
Phone: +30 (0)1-3426076, Fax: +30 (0)1-3455578
E-mail: parianos@hol.gr
http://www.smceu.com



Poland

SMC Industrial Automation Polska Sp.z.o.o.
ul. Konstruktorska 11A, PL-02-673 Warszawa,
Phone: +48 22 548 5085, Fax: +48 22 548 5087
E-mail: office@smc.pl
http://www.smc.pl



Switzerland

SMC Pneumatik AG
Dorfstrasse 7, CH-8484 Weisslingen
Phone: +41 (0)52-396-3131, Fax: +41 (0)52-396-3191
E-mail: info@smc.ch
http://www.smc.ch



Croatia

SMC Industrijska automatika d.o.o.
Cromerec 12, 10000 ZAGREB
Phone: +385 1 377 66 74, Fax: +385 1 377 66 74
E-mail: office@smc.hr
http://www.smceu.com



Hungary

SMC Hungary Ipari Automatizálási Kft.
Budafoki út 107-113, H-1117 Budapest
Phone: +36 1 371 1343, Fax: +36 1 371 1344
E-mail: office@smc-automation.hu
http://www.smc-automation.hu



Portugal

SMC Sucursal Portugal, S.A.
Rua de Engº Ferreira Dias 452, 4100-246 Porto
Phone: +351 22-610-89-22, Fax: +351 22-610-89-36
E-mail: postpt@smc.smces.es
http://www.smces.es



Turkey

Entek Pnömatik San. ve Tic Ltd. Sti.
Peipa Tic. Merkezi Kat: 11 No: 1625, TR-80270 Okmeydanı Istanbul
Phone: +90 (0)212-221-1512, Fax: +90 (0)212-221-1519
E-mail: smc-entek@entek.com.tr
http://www.entek.com.tr



Czech Republic

SMC Industrial Automation CZ s.r.o.
Hudcova 78a, CZ-61200 Brno
Phone: +420 5 414 24611, Fax: +420 5 412 18034
E-mail: office@smc.cz
http://www.smc.cz



Ireland

SMC Pneumatics (Ireland) Ltd.
2002 Citywest Business Campus, Naas Road, Saggart, Co. Dublin
Phone: +353 (0)1-403 9000, Fax: +353 (0)1-464-0500
E-mail: sales@smcpneumatics.ie
http://www.smcpneumatics.ie



Romania

SMC Romania srl
Str Frunzei 29, Sector 2, Bucharest
Phone: +40 213205111, Fax: +40 213261489
E-mail: smcromania@smcromania.ro
http://www.smcromania.ro



UK

SMC Pneumatics (UK) Ltd
Vincent Avenue, Crownhill, Milton Keynes, MK8 0AN
Phone: +44 (0)800 1382930 Fax: +44 (0)1908-555064
E-mail: sales@smcpneumatics.co.uk
http://www.smcpneumatics.co.uk



Denmark

SMC Pneumatik A/S
Knudsminde 4B, DK-8300 Odder
Phone: +45 70252900, Fax: +45 70252901
E-mail: smc@smc-pneumatik.dk
http://www.smc-pneumatik.com



Italy

SMC Italia S.p.A
Via Garibaldi 62, I-20061 Carugate, (Milano)
Phone: +39 (0)2-92711, Fax: +39 (0)2-9271365
E-mail: mailbox@smcitalia.it
http://www.smcitalia.it



Russia

SMC Pneumatik LLC.
Sredny pr. 36/40, St. Petersburg 199004
Phone: +812 118 5445, Fax: +812 118 5449
E-mail: marketing@smc-pneumatik.ru
http://www.smc-pneumatik.ru



Estonia

SMC Pneumatics Estonia OÜ
Laki 12-101, 106 21 Tallinn
Phone: +372 (0)6 593540, Fax: +372 (0)6 593541
E-mail: smc@smcpneumatics.ee
http://www.smcpneumatics.ee



Latvia

SMC Pneumatics Latvia SIA
Smerla 1-705, Riga LV-1006, Latvia
Phone: +371 781-77-00, Fax: +371 781-77-01
E-mail: info@smclv.lv
http://www.smclv.lv



Slovakia

SMC Priemyselna Automatizacia, s.r.o.
Námestie Martina Benku 10, SK-81107 Bratislava
Phone: +421 2 444 56725, Fax: +421 2 444 56028
E-mail: office@smc.sk
http://www.smc.sk



Finland

SMC Pneumatics Finland OY
PL72, Tiistiniityntie 4, SF-02031 ESPOO
Phone: +358 207 513513, Fax: +358 207 513595
E-mail: smcfi@smc.fi
http://www.smc.fi



Lithuania

SMC Pneumatics Lietuva, UAB
Savanoriu pr. 180, LT-01354 Vilnius, Lithuania
Phone: +370 5 264 81 26, Fax: +370 5 264 81 26



Slovenia

SMC industrijska Avtomatika d.o.o.
Grajski trg 15, SLO-8360 Zuzemberk
Phone: +386 738 85240 Fax: +386 738 85249
E-mail: office@smc-ind-avtom.si
http://www.smc-ind-avtom.si



OTHER SUBSIDIARIES WORLDWIDE:

ARGENTINA, AUSTRALIA, BOLIVIA, BRASIL, CANADA, CHILE,
CHINA, HONG KONG, INDIA, INDONESIA, MALAYSIA, MEXICO,
NEW ZEALAND, PHILIPPINES, SINGAPORE, SOUTH KOREA,
TAIWAN, THAILAND, USA, VENEZUELA

<http://www.smceu.com>
<http://www.smcworld.com>

SMC CORPORATION

1-16-4 Shimbashi, Minato-ku, Tokio 105 JAPAN; Phone:03-3502-2740 Fax:03-3508-2480

1st printing JS printing JS 30 UK Printed in Spain

Specifications are subject to change without prior notice
and any obligation on the part of the manufacturer.